

ARK LANI

2022/23 3&6 MM COLLECTION

ARK
LANI
QUALITY DOESN'T FEAR TIME

ARK
LANI

QUALITY DOESN'T FEAR TIME

PHILOSOPHY

FILOSOFÍA

Arklam arises to respond to the new needs of professionals in architecture and interior decoration.

With this vocation, Arklam has consolidated itself as a reference product for its exceptional technical features, which represent a step forward in the coating of all types of surfaces.

Arklam is an innovative solution of large format sintered mass, which stands out for its resistance, durability and design and which has been created specifically for the most exclusive and demanding projects.

Arklam surge para dar respuesta a las nuevas necesidades de los profesionales de la arquitectura y la decoración de interiores.

Con esta vocación, Arklam se ha consolidado como un producto de referencia por sus excepcionales prestaciones técnicas, que suponen un paso más allá en el recubrimiento de todo tipo de superficies.

Arklam es una innovadora solución de masa sinterizada de gran formato, que sobresale por su resistencia, durabilidad y diseño y que ha sido creada específicamente para los proyectos más exclusivos y exigentes.

www.arklam.com



WALL · Gris Levante Natural 1200x3000 Rect.

ARK
LAM
QUALITY DOESN'T FEAR TIME



WALL · Saint Laurent Natural 1200x3000 Rect.
FLOOR · Corymbia Honey Matt 23x120

SLIM THICKNESS / 3&6_{mm}

Arklam collection is a new sintered mass concept that provides solutions for interior use with character and personality. Born as a result of a deep study of decorative trends and the most contemporary demands.

Its lightness and large dimensions make it an ideal material for interiors, ventilated facades, as well as for rehabilitation projects. Besides it can be applied directly on the existing surface, saving costs and handling times.

Another of its special characteristics is its thin thickness of 3 and 6 mm, with option to mesh in the 3 mm, and its five finishes: Silk, Polished, River Washed, Natural and Hond.

100% Made in Spain

La colección Arklam es una nueva masa sinterizada que aporta soluciones para interiores con carácter y personalidad, nacida del profundo estudio de las tendencias decorativas y las demandas más contemporáneas.

Su ligereza y sus grandes dimensiones lo convierten en un material idóneo tanto para interiores, como para fachadas ventiladas y proyectos de rehabilitación, pudiéndose aplicar directamente sobre la superficie ya existente, ahorrando costes y tiempos de manipulación.

Otra de sus características especiales es su fino espesor de 3 y 6 mm, con opción de enmallado en el 3 mm, y sus cinco acabados: Silk, Polished, River Washed, Natural y Hond.

100% Hecho en España

ARK
LAM
QUALITY DOESN'T FEAR TIME



GENERAL INDEX

ÍNDICE GENERAL

•	
Arklam Collection / Colección Arklam	8
Format & Thickness / Formato y Espesor	12
Properties / Propiedades	13
Applications / Aplicaciones	14
Characteristics / Características	16
Our Collection 3&6mm / Nuestra Colección 3&6mm	18
Grouts / Rejuntas	282
Packing / Embalaje	285
Technical Characteristics / Características Técnicas	286
Arklam Skin	288
Arktech GL System	296
Arktech VST System	304
Arktech FULL System	312
Certifications & Awards / Certificados y Distinciones	324

ARKLAM COLLECTION

COLECCIÓN ARKLAM

COLLECTIONS	1600x3200						1200x3000					1200x2800	1000x3000				1500x2600	1200x2600		
	12 mm			20 mm			6 mm					6 mm	3 mm	3 mm+	6 mm			6 mm	6 mm	
	POLISHED	SILK	HOND	NATURAL	BUSH HAMMERED	RIVER WASHED	POLISHED	SILK	HOND	NATURAL	RIVER WASHED	NATURAL	SILK	POLISHED	SILK	NATURAL	RIVER WASHED	POLISHED	SILK	
AGORA VISON					●															
ALMA						●														
AMSTERDAM GREY				●																
AQUA											●									
ARABESCATTO CORCHIA	●																			
ARCANE				●																
ATLANTIS	●	●									●	●						●	●	
ATLANTIS GOLD	●	●									●	●								
ATRIUM BEIGE																●				
ATRIUM PEARL																●				
ATRIUM GREY																●				
ATRIUM ANTHRACITE																●				
AVENUE WHITE												●								
AVENUE ASH												●								
AVENUE TAUPE												●								
AVENUE GRAPHITE												●								
BASALT GREY	●																			
BATEIG BLUE				●												●				
BATEIG VERONA				●												●				
BOTANICAL COLD																	●			
BOTANICAL WARM																	●			
BRAZIL SUPER WHITE			●												●					
CALACATTA GOLD			●									●			●					
CALACATTA GREEN												●			●					
CALACATTA PAONAZZO	●		●									●			●					
CANADA	●																			
CHROMATICA BLUE												●								

COLLECTIONS	1600x3200						1200x3000					1200x2800	1000x3000				1500x2600	1200x2600		
	12 mm			20 mm			6 mm					6 mm	3 mm	3 mm+	6 mm			6 mm	6 mm	
	POLISHED	SILK	HOND	NATURAL	BUSH HAMMERED	RIVER WASHED	POLISHED	SILK	HOND	NATURAL	RIVER WASHED	NATURAL	SILK	POLISHED	SILK	NATURAL	RIVER WASHED	POLISHED	SILK	
CONCRETE																			●	●
COPENHAGUEN WHITE																				●
ESTUARIO	●		●						●		●				●					
FLORI DELUNA																●				
GARLAND BEIGE																			●	
GARLAND SAND																			●	
GARLAND HAZELNUT																			●	
GARLAND PEARL																			●	
GARLAND SILVER																			●	
GARLAND GREY																			●	
GARLAND DARK GREY																			●	
GLACIAR																			●	●
GRIS LEVANTE				●												●				
INVISIBLE GREY	●		●																	
JURASSIC BLACK																			●	
JURASSIC GOLD																			●	
LILAC			●													●				
LONDRA BLACK																			●	
LONDRA GREY																			●	
MANHATTAN WHITE																			●	
MANHATTAN BEIGE																			●	
MANHATTAN GREY		●																	●	
MYFAIR OAK																			●	
MELBOURNE			●																●	
MELBOURNE DECOR																			●	
MIRAGE GREY																			●	
MYSTIC GREY																			●	

ARKLAM COLLECTION

COLECCIÓN ARKLAM

COLLECTIONS	1600x3200						1200x3000					1200x2800	1000x3000				1500x2600		1200x2600					
	12 mm			20 mm			6 mm					6 mm	3 mm	3 mm+	6 mm		6 mm		6 mm					
	POLISHED	SILK	HOND	NATURAL	BUSH HAMMERED	RIVER WASHED	POLISHED	SILK	HOND	NATURAL	POLISHED	SILK	HOND	NATURAL	RIVER WASHED	NATURAL	SILK	POLISHED	SILK	NATURAL	RIVER WASHED	POLISHED	SILK	POLISHED
NEGRO MARQUINA	•	•								•	•						•	•						
OMNIA WHITE										•		•												
ONICE BLACK										•														
ONIX BEIGE										•														
ONIX JADE										•														
ONIX PEARL										•														
ONIX TURQUOISE										•														•
PALISANDRO BLUE										•								•	•					
PANDORA										•	•							•	•					
PATAGONIA GOLD										•														
PHOENIX BLUE											•													
PIER17 COPPER																						•		
PIER17 ZINC																						•		
PIETRA CORAL																						•		
PIETRA CORAL PEARL																						•		
PIETRA CORAL SAND																						•		
POMPEIA												•										•		
POMPEIA DECOR																						•		
PORTLAND																						•		
PORTOBELLO																						•	•	
PULPIS NATURAL		•																				•		
PURE BLACK			•																			•	•	
PURE GREY			•																			•		
PURE IVORY																						•	•	
PURE SUPER WHITE	•		•																			•	•	
PURE VISON			•																			•		
PURE WHITE																						•		

COLLECTIONS	1600x3200						1200x3000					1200x2800	1000x3000				1500x2600		1200x2600					
	12 mm			20 mm			6 mm					6 mm	3 mm	3 mm+	6 mm		6 mm		6 mm					
	POLISHED	SILK	HOND	NATURAL	BUSH HAMMERED	RIVER WASHED	POLISHED	SILK	HOND	NATURAL	POLISHED	SILK	HOND	NATURAL	RIVER WASHED	NATURAL	SILK	POLISHED	SILK	NATURAL	RIVER WASHED	POLISHED	SILK	POLISHED
ROSA PERSIA			•												•		•							
SAHARA NOIR			•																			•	•	
SAINT LAURENT				•											•									
SEVEN BEIGE																								•
SEVEN SAND																								•
SEVEN HAZELNUT				•																				•
SEVEN PEARL																								•
SEVEN SILVER																								•
SEVEN GREY																								•
SEVEN DARK GREY																								•
SIDNEY MOKA																								•
SYRAC			•												•		•							•
TRAVERTINO GREY																						•		•
TRAVERTINE NAVONA																						•		
VILLAGE		•																						
VULCANO		•																						

FORMAT & THICKNESS

FORMATO Y ESPESOR

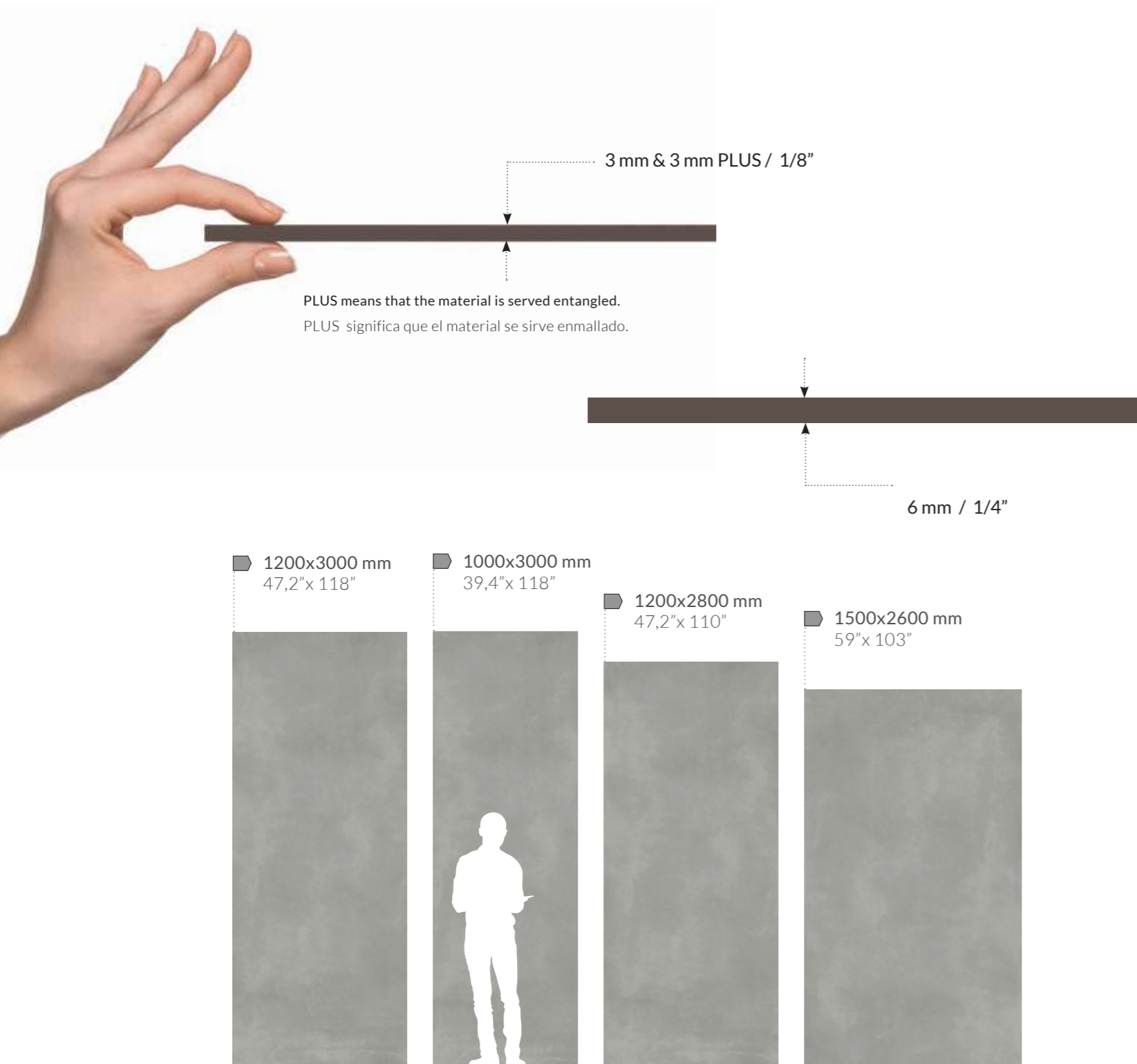

Our product is characterized by being a thin resistant sheet of 3 and 6 mm of thickness. This material offers a mechanical and aesthetic performance suitable for different uses.

It adapts to interior designs, capable of satisfying the needs of all design projects, since it can be applied as pavement (except thickness of 3 mm & 3 mm Plus), both interior and exterior, as well as for interior and exterior cladding (ventilated facades).

Nuestro producto se caracteriza por ser una fina lámina resistente de 3 y 6 mm de espesor. Este material ofrece unas prestaciones mecánicas y estéticas idóneas para los diferentes usos que se le pretenden dar.

Se adapta a un diseño de interiores capaz de satisfacer las necesidades de todos los proyectos de diseño, ya que se puede aplicar como pavimento (excepto el espesor de 3 mm y 3 mm Plus), tanto interior como exterior, o como revestimiento interior o exterior (fachadas ventiladas).

Consult your sales agent for custom cut options, for different format requests.

Consulta a tu agente de ventas para opciones de corte a medida si necesitas otros formatos.

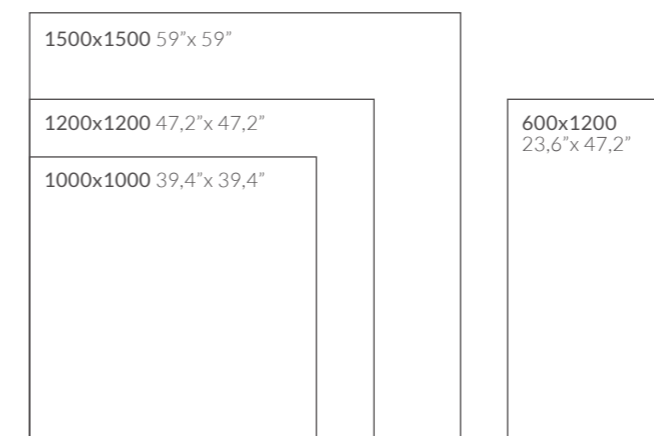

PROPERTIES

PROPIEDADES

-  **Highly UV Resistant**
Resistente a los rayos UV
-  **Frost resistance**
Resistente a las heladas
-  **Waterproof**
Impermeable
-  **Resistance to high temperatures**
Resistente a altas temperaturas
-  **Lightness**
Ligereza
-  **Resistant to scratches**
Resistencia al rayado
-  **Resistant to stains**
Resistente a las manchas
-  **Recyclable**
Reciclable
-  **Easy to clean**
Fácil de limpiar
-  **Resistant to chemical attack**
Resistencia al ataque químico

APPLICATIONS

APLICACIONES

ARK
Home
LAM

QUALITY DOESN'T FEAR TIME



Arklam Home is a sintered mass solution suitable for both indoor and outdoor applications, which can be applied directly to the existing surface, saving costs and handling time. Lightness, resistance, large format and thin thickness are its main characteristics.

Arklam Home es una solución de masa sinterizada idónea tanto para interiores y exteriores, que puede aplicarse directamente sobre la superficie ya existente, ahorrando costes y tiempos de manipulación. Ligereza, resistencia, gran formato y fino espesor son sus principales características.

ARK
Style
LAM

QUALITY DOESN'T FEAR TIME



Arklam Style collects all stylistic possibilities with amazing realism, allowing designers to unleash their creativity and interior designers to find what they are looking for. Sophisticated and exclusive collections. A range of decorations with an innovative idea of expression for residential architecture as well as for public and residential spaces.

Arklam Style recoge todas las posibilidades estilísticas con un realismo asombroso, permitiendo a los diseñadores desatar su creatividad y a los interioristas encontrar lo que buscan. Colecciones sofisticadas y exclusivas. Una gama de decorados con una idea innovadora de expresión tanto para la arquitectura residencial como para espacios públicos y residenciales.

ARK
Concept
LAM

QUALITY DOESN'T FEAR TIME



Arklam Concept opens up endless possibilities for creating unique furniture. Arklam is a material suitable for covering structures made of metal or wood to obtain tables, cupboards, shelves, chimneys, etc. with a powerful load of design and exclusivity.

Arklam Concept abre un sinfín de posibilidades para crear mobiliario único. Arklam es un material adecuado para recubrir estructuras realizadas con metal o con madera y obtener así mesas, armarios, estanterías, chimeneas, etc. con una potente carga de diseño y exclusividad.

ARK
Skin
LAM

QUALITY DOESN'T FEAR TIME



Arklam Skin is Arklam's line of ventilated facades. The advantages of this range of large format sintered dough for dressing the skin of all types of buildings are multiple: Lightness, maximum resistance, sustainability, simple maintenance and exceptional finishes.

Arklam Skin es la línea de fachadas ventiladas de Arklam. Las ventajas de esta gama de masa sinterizada de gran formato para vestir la piel de todo tipo de edificaciones son múltiples: Ligereza, máxima resistencia, sostenibilidad, sencillo mantenimiento y excepcionales acabados.

CHARACTERISTICS CARACTERÍSTICAS



THIN · FINO

Maximum strength with minimum thickness. Arklam is a sintered mass with a higher density than other materials used to coat surfaces and its durability is totally guaranteed.

Máxima resistencia con mínimo grosor. Arklam es una masa sinterizada con una mayor densidad que otros materiales empleados para revestir superficies y su durabilidad está totalmente garantizada.



EXCLUSIVITY · EXCLUSIVIDAD

Arklam it's an absolute trend. Exclusivity and avant-garde aesthetics to dress every space in a modern way. Arklam is fashion with a timeless character.

Arklam es absoluta tendencia. Exclusividad y estética vanguardista para vestir de plena actualidad cada espacio. Arklam es moda con carácter atemporal.



LIGHT · LIGERO

Arklam is an extremely light product, a quality that facilitates its handling and placement and contributes to achieving a perfect finish and always at the height of the most demanding projects.

Arklam es un producto sumamente ligero, una cualidad que facilita su manipulación y colocación y contribuye a alcanzar un acabado perfecto y siempre a la altura de los proyectos más exigentes.



DESIGN · DISEÑO

Because variety is important, Arklam Super Size Collection allows you to choose from a rich diversity of designs of all styles. Each series presents differentiated graphics to obtain personalized and plentiful finishes in shades.

Porque en la variedad está el gusto, Arklam Super Size Collection permite elegir entre una rica diversidad de diseños de todos los estilos. Cada serie presenta gráficas diferenciadas para obtener acabados personalizados y abundantes en matices.

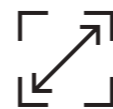

SUPER SIZE · GRAN FORMATO

Big in size, big in performance.
With Arklam all the advantages are XXL.

Grande en tamaño, grande en prestaciones.
Con Arklam todas las ventajas son XXL.



INNOVATION · INNOVACIÓN

Arklam is the result of a constant commitment to technological innovation. The latest advances in R+D incorporated into the manufacturing process allow us to enjoy a product with extraordinary qualities.

Arklam es el resultado de una constante apuesta por la innovación tecnológica. Los últimos avances en I+D incorporados al proceso de fabricación permiten disfrutar de un producto con cualidades extraordinarias.



WALL · Travertine Navona Hond 1200x3000 Rect.

ARK
LAM
QUALITY DOESN'T FEAR TIME

OUR COLLECTION

NUESTRA COLECCIÓN

MARBLES/ MÁRMOLES

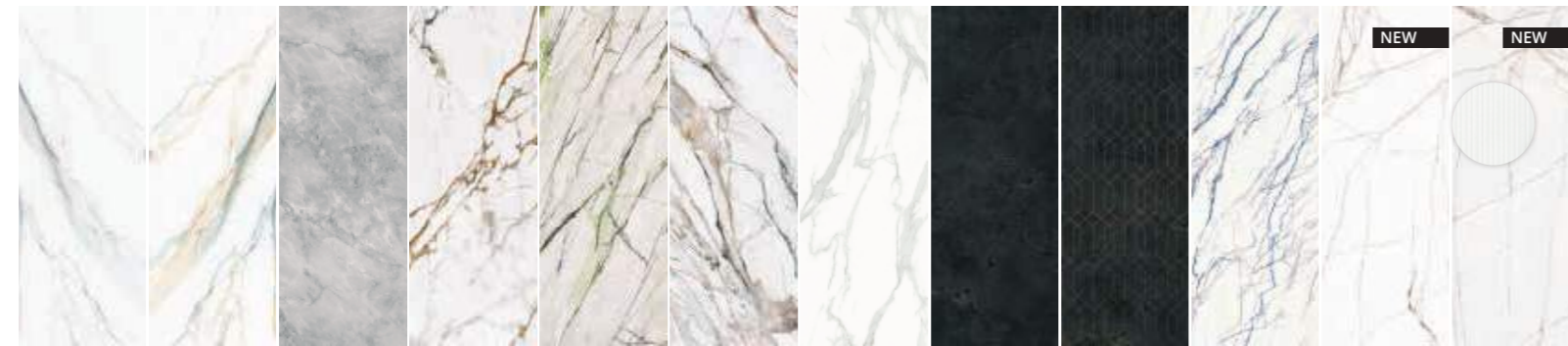

24 ATLANTIS POLISHED / SILK 1200x3000 1500x2600
 28 ATLANTIS GOLD POLISHED / SILK 1200x3000
 32 BRAZIL SUPER WHITE HOND 1200x3000
 36 CALACATTA GOLD POLISHED / HOND 1200x3000
 42 CALACATTA GREEN POLISHED / HOND 1200x3000
 46 CALACATTA PAONAZZO POLISHED / HOND 1200x3000
 50 ESTATUARIO POLISHED / HOND 1200x3000
 56 JURASSIC BLACK POLISHED 1200x3000
 58 JURASSIC GOLD POLISHED 1200x3000
 60 LILAC POLISHED 1200x3000
 66 MELBOURNE HOND 1200x3000
 70 MELBOURNE DECOR HOND 1200x3000

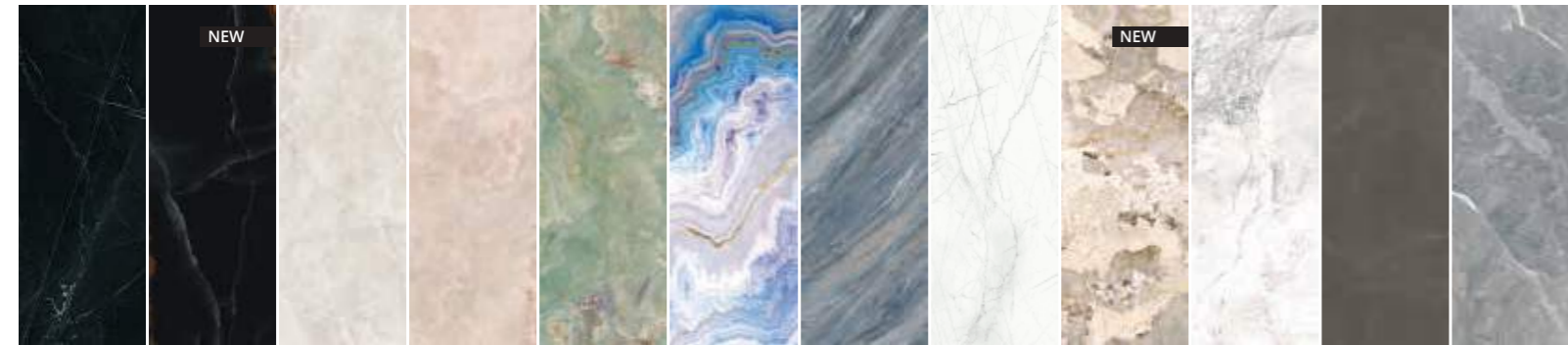

72 NEGRO MARQUINA POLISHED / SILK 1200x3000 1000x3000
 74 ONICE BLACK POLISHED 1200x3000
 78 ONIX PEARL POLISHED 1200x3000
 80 ONIX BEIGE POLISHED 1200x3000
 82 ONIX JADE POLISHED 1200x3000
 88 ONIX TURQUOISE POLISHED 1200x2600
 92 PALISANDRO BLUE POLISHED 1200x3000 1000x3000
 96 PANDORA POLISHED / SILK 1200x3000 1000x3000
 100 PATAGONIA GOLD POLISHED BL 1200x3000
 106 PORTOBELLO POLISHED / SILK 1200x3000 1000x3000
 108 PULPIS NATURAL SILK 1200x3000 1000x3000
 110 ROSA PERSIA POLISHED / HOND 1200x3000

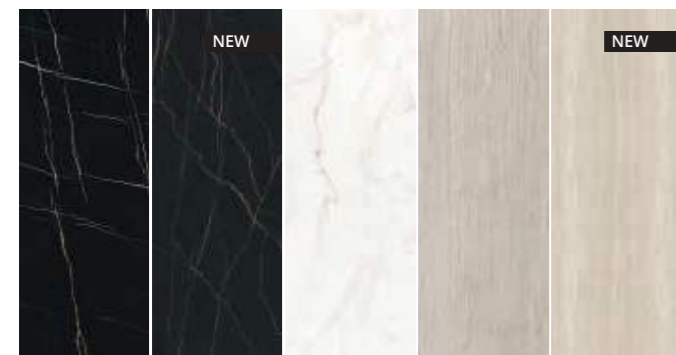

116 SAHARA NOIR POLISHED / SILK 1200x3000 1000x3000
 118 SAINT LAURENT NATURAL 1200x3000
 122 SYRAC POLISHED / HOND 1200x3000
 128 TRAVERTINO GREY RIVER WASHED 1000x3000
 130 TRAVERTINE NAVONA HOND 1200x3000

CONCRETE&STONES / CEMENTOS Y PIEDRAS



136 ATRIUM BEIGE NATURAL 1200x3000
 138 ATRIUM PEARL NATURAL 1200x3000
 140 ATRIUM GREY NATURAL 1200x3000
 142 ATRIUM ANTHRACITE NATURAL 1200x3000
 144 AVENUE WHITE SILK 1200x3000
 146 AVENUE ASH SILK 1200x3000
 148 AVENUE TAUPE SILK 1200x3000
 150 AVENUE GRAPHITE SILK 1200x3000
 152 BATEIG BLUE NATURAL 1200x3000
 156 BATEIG VERONA NATURAL 1200x3000
 160 CHROMATICA BLUE SILK 1200x3000
 162 PHOENIX BLUE SILK 1200x3000



166 COPENHAGUEN WHITE SILK 1500x2600
 168 GRIS LEVANTE NATURAL 1200x3000
 172 LONDRA BLACK SILK 1200x3000 1000x3000
 174 LONDRA GREY SILK 1200x3000
 176 MANHATTAN WHITE SILK 1200x3000 1000x3000
 178 MANHATTAN BEIGE SILK 1200x3000 1000x3000
 180 MANHATTAN GREY SILK 1200x3000 1000x3000
 182 MYSTIC GREY POLISHED / NATURAL 1200x3000
 186 OMNIA WHITE POLISHED / HOND 1200x3000
 190 PIER17 COPPER NATURAL 1200x3000
 192 PIER 17 ZINC NATURAL 1200x3000
 194 PIETRA CORAL NATURAL 1200x3000



196 PIETRA CORAL PEARL NATURAL 1200x3000
 198 PIETRA CORAL SAND NATURAL 1200x3000
 202 POMPEIA SILK 1200x3000 1000x3000
 204 POMPEIA DECOR SILK 1000x3000
 208 PORTLAND STONE NATURAL 1200x3000
 214 SEVEN BEIGE NATURAL 1200x2800
 216 GARLAND BEIGE NATURAL 1200x2800
 218 SEVEN SAND NATURAL 1200x2800
 220 GARLAND SAND NATURAL 1200x2800
 222 SEVEN HAZELNUT NATURAL 1200x2800
 224 GARLAND HAZELNUT NATURAL 1200x2800
 226 BOTANICAL WARN NATURAL 1200x2800

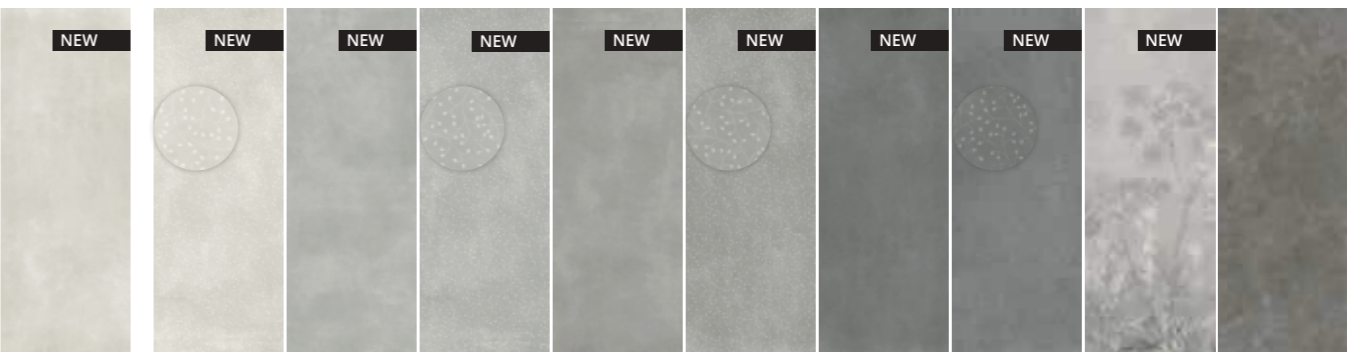

230 SEVEN PEARL NATURAL 1200x2800
 232 GARLAND PEARL NATURAL 1200x2800
 234 SEVEN SILVER NATURAL 1200x2800
 236 GARLAND SILVER NATURAL 1200x2800
 238 SEVEN GREY NATURAL 1200x2800
 240 GARLAND GREY NATURAL 1200x2800
 242 SEVEN DARK GREY NATURAL 1200x2800
 244 GARLAND DARK GREY NATURAL 1200x2800
 246 BOTANICAL COLD NATURAL 1200x2800
 250 SIDNEY MOKA NATURAL 1000x3000

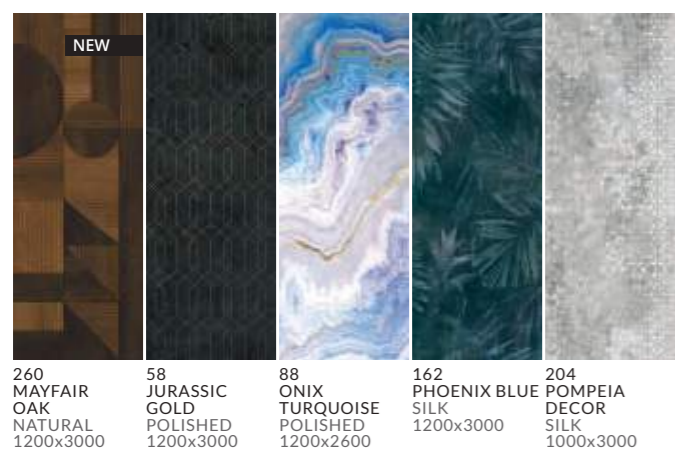

CONCRETE/CEMENTO

3 MM & 3 MM Plus



266
CONCRETE
SILK
1200x3000

BASIC LINE

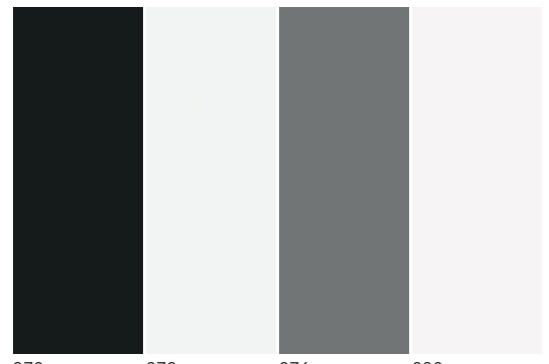

270 PURE BLACK POLISHED / SILK 1200x3000	272 GLACIAR POLISHED / SILK 1000x3000 1500x2600	276 PURE GREY SILK 1000x3000	280 PURE WHITE SILK 1200x3000
--	--	---------------------------------------	--

3 MM & 3 MM Plus

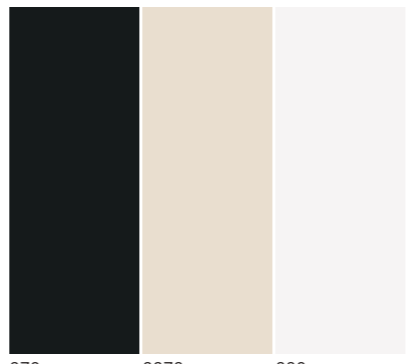

270 PURE BLACK SILK 1000x3000	2278 PURE IVORY SILK 1000x3000	280 PURE WHITE SILK 1000x3000
--	---	--

*PLUS means that the material is served entangled / PLUS significa que el material se sirve enmallado.



FLOOR · Avenue Graphite Silk 1200x3000 Rect.



ARK
LAMI
QUALITY DOESN'T FEAR TIME

MARBLES
COLLECTION
COLLECTION MÁRMOLES

ATLANTIS

ARK
LAMI

▼
6 mm
▲

POLISHED / SILK

1200x3000 mm/ 47,2"x118"
Atlantis Polished 1200x3000 Rect.
Atlantis Silk 1200x3000 Rect.

1500x2600 mm/ 50"x103"
Atlantis Polished 1500x2600 Rect.
Atlantis Silk 1500x2600 Rect.

9 DESIGNS / 9 DISEÑOS

▼
12 mm
▲

POLISHED / SILK

1600x3200 mm/ 63"x126"
Atlantis Polished 1600x3200
Atlantis Silk 1600x3200

2 DESIGNS / 2 DISEÑOS



WALL&FLOOR - Atlantis Polished 1200x3000 Rect.

ATLANTIS
OPENBOOK

The pieces reflect each other as if they were an open book.
Openbook included within the 9 graphics.
Las piezas se reflejan entre sí como si fueran un libro abierto.
Openbook incluido dentro de las 9 gráficas.

Suggested placement
Sugerencia de colocación



WALL&FLOOR - Atlantis Silk 1500x2600 Rect.

ARK
LANI
QUALITY DOESN'T FEAR TIME

ATLANTIS GOLD

ARK
LAMI

▼
6 mm
▲

POLISHED / SILK

1200x3000 mm/ 47,2"x118"

Atlantis Gold Polished 1200x3000 Rect.
Atlantis Gold Silk 1200x3000 Rect.

9 DESIGNS / 9 DISEÑOS

▼
12 mm
▲

POLISHED / SILK

1600x3200 mm/ 63"x126"

Atlantis Gold Polished 1600x3200
Atlantis Gold Silk 1600x3200

2 DESIGNS / 2 DISEÑOS



FLOOR · Atlantis Gold Polished 1200x3000 Rect.

ATLANTIS GOLD

OPENBOOK

The pieces reflect each other as if they were an open book.
Openbook included within the 9 graphics.
Las piezas se reflejan entre sí como si fueran un libro abierto.
Openbook incluido dentro de las 9 gráficas.

Suggested placement
Sugerencia de colocación



WALL&FLOOR · Atlantis Gold Polished 1200x3000 Rect.
COUNTERTOP · Atlantis Gold Silk 1600X3200

BRAZIL SUPER WHITE

ARK
LAMI

▼
6 mm
▲

HOND
1200x3000 mm/ 47,2"x118"
Brazil Super White Hond 1200x3000 Rect.
3 DESIGNS / 3 DISEÑOS

▼
12 mm
▲

HOND
1600x3200 mm/ 63"x126"
Brazil Super White Hond 1600x3200
1 SINGLE DESIGN / 1 ÚNICO DISEÑO

▼
20 mm
▲

HOND
1600x3200 mm/ 63"x126"
Brazil Super White Hond 1600x3200
1 SINGLE DESIGN / 1 ÚNICO DISEÑO



WALL - Brazil Super White Hond 1200x3000 Rect. / Atrium Anthracite Natural 1200x3000 Rect.
FLOOR - Brazil Super White Hond 1200x3000 Rect.

BRAZIL SUPER WHITE

•
ENDLESS

The different designs of the pieces allow creating an infinite effect by succesively placing the pieces in their original position.
Los diferentes diseños de las piezas permiten crear un efecto infinito colocando sucesivamente las piezas en su posición original.

Suggested placement
Sugerencia de colocación



*3 different pieces/designs come mixed in boxes
*3 piezas diferentes se sirven aleatoriamente en las cajas



WALL · Brazil Super White Hond 1200x3000 Rect.

ARK
LANI
QUALITY DOESN'T FEAR TIME



CALACATTA GOLD

ARK
LAM

▼
6 mm
▲

POLISHED / HOND

1200x3000 mm/ 47,2"x118"
Calacatta Gold Polished 1200x3000 Rect.
Calacatta Gold Hond 1200x3000 Rect.

3 DESIGNS / 3 DISEÑOS

▼
12 mm
▲

HOND

1600x3200 mm/ 63"x126"
Calacatta Gold Hond 1600x3200

1 SINGLE DESIGN / 1 ÚNICO DISEÑO

▼
20 mm
▲

HOND

1600x3200 mm/ 63"x126"
Calacatta Gold Hond 1600x3200

1 SINGLE DESIGN / 1 ÚNICO DISEÑO

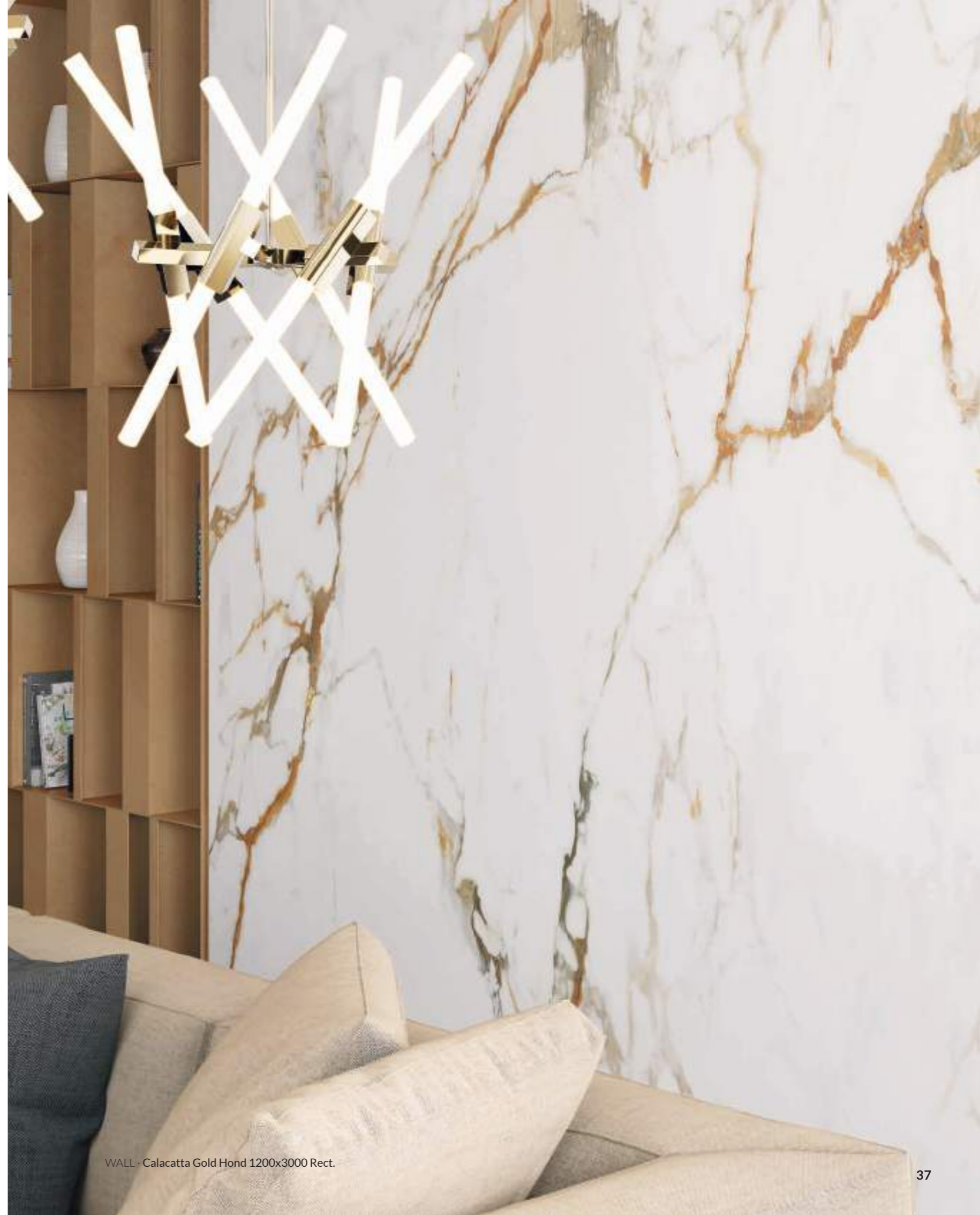

WALL - Calacatta Gold Hond 1200x3000 Rect.

ARK
LAMI
QUALITY DOESN'T FEAR TIME



WALL&FLOOR · Calacatta Gold Polished 1200x3000 Rect.

CALACATTA GOLD

ENDLESS

The different designs of the pieces allow creating an infinite effect by succesively placing the pieces in their original position.
Los diferentes diseños de las piezas permiten crear un efecto infinito colocando sucesivamente las piezas en su posición original.

Suggested placement
Sugerencia de colocación



*3 different pieces/designs come mixed in boxes
*3 piezas diferentes se sirven aleatoriamente en las cajas



WALL · Calacatta Gold Polished 1200x3000 Rect.

ARK
LANI
QUALITY DOESN'T FEAR TIME

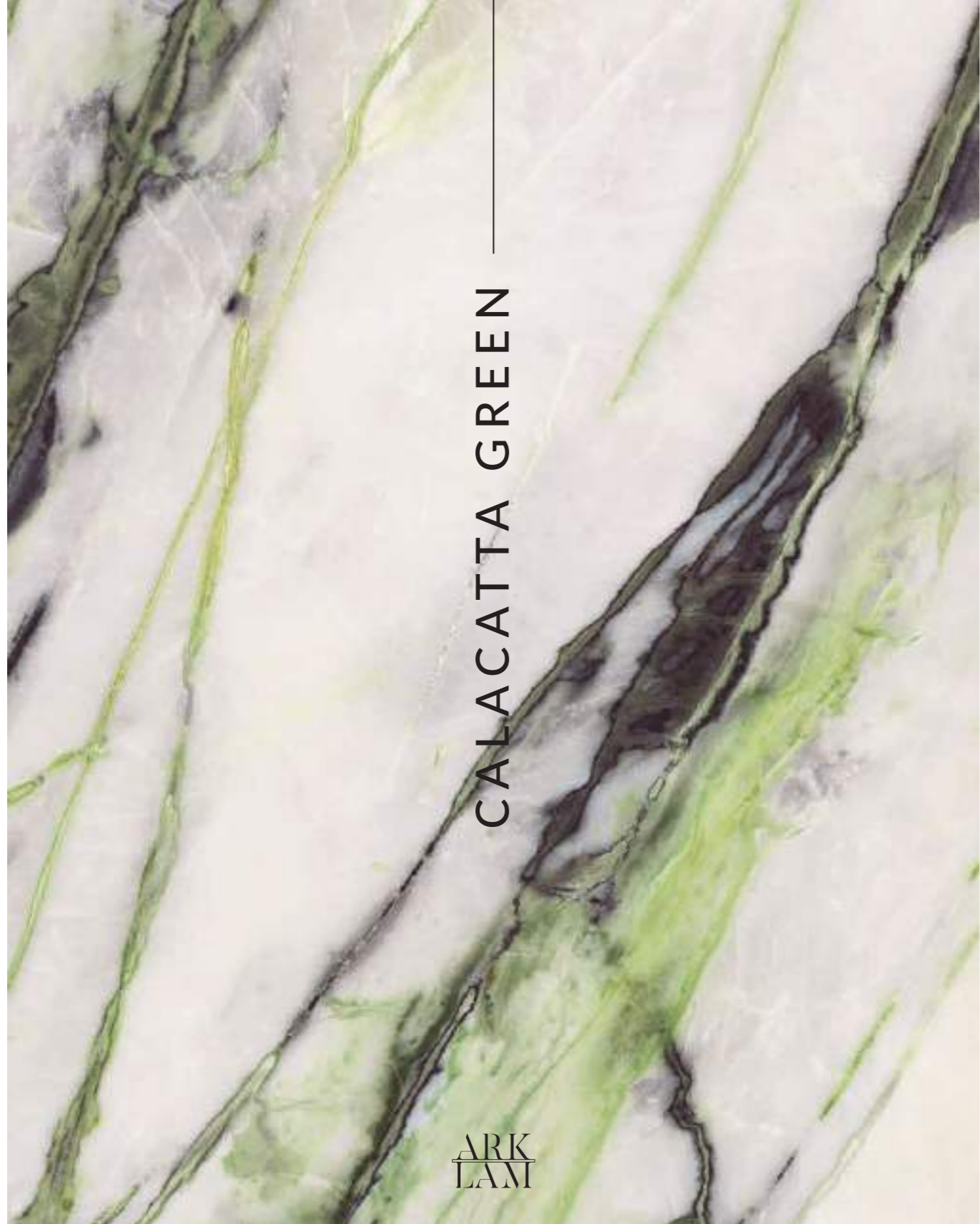

▼
6 mm
▲

POLISHED / HOND
1200x3000 mm/ 47,2"x118"
Calacatta Green Polished 1200x3000 Rect.
Calacatta Green Hond 1200x3000 Rect.
3 DESIGNS / 3 DISEÑOS



CALACATTA GREEN

ENDLESS

The different designs of the pieces allow creating an infinite effect by succesively placing the pieces in their original position.
Los diferentes diseños de las piezas permiten crear un efecto infinito colocando sucesivamente las piezas en su posición original.

Suggested placement
Sugerencia de colocación



*3 different pieces/designs come mixed in boxes
*3 piezas diferentes se sirven aleatoriamente en las cajas



WALL&FLOOR - Calacatta Green Polished 1200x3000 Rect

ARK
LANI
QUALITY DOESN'T FEAR TIME



CALACATTA PAONAZZO

ARK
LAMI

▼
6 mm
▲

POLISHED / HOND

1200x3000 mm / 47,2"x118"

Calacatta Paonazzo Polished 1200x3000 Rect.
Calacatta Paonazzo Hond 1200x3000 Rect.

3 DESIGNS / 3 DISEÑOS

▼
12 mm
▲

POLISHED / HOND

1600x3200 mm / 63"x126"

Calacatta Paonazzo Polished 1600x3200
Calacatta Paonazzo Hond 1600x3200

2 DESIGNS / 2 DISEÑOS

▼
20 mm
▲

POLISHED / HOND

1600x3200 mm / 63"x126"

Calacatta Paonazzo Polished 1600x3200
Calacatta Paonazzo Hond 1600x3200

1 SINGLE DESIGN / 1 ÚNICO DISEÑO



WALL&FLOOR · Calacatta Paonazzo Polished 1200x3000 Rect.

CALACATTA PAONAZZO

ENDLESS

The different designs of the pieces allow creating an infinite effect by successively placing the pieces in their original position.
Los diferentes diseños de las piezas permiten crear un efecto infinito colocando sucesivamente las piezas en su posición original.

Suggested placement
Sugerencia de colocación



*3 different pieces/designs come mixed in boxes
*3 piezas diferentes se sirven aleatoriamente en las cajas



WALL&FLOOR - Calacatta Paonazzo Hond 1200x3000 Rect.

ESTATUARIO

ARK
LAMI

▼
6 mm
▲

POLISHED / HOND

1200x3000 mm/ 47,2"x118"

Estatuario Polished 1200x3000 Rect.
Estatuario Hond 1200x3000 Rect.

6 DESIGNS / 6 DISEÑOS

▼
12 mm
▲

POLISHED / HOND

1600x3200 mm/ 63"x126"

Estatuario Polished 1600x3200
Estatuario Hond 1600x3200

2 DESIGNS / 2 DISEÑOS

▼
20 mm
▲

POLISHED / HOND

1600x3200 mm/ 63"x126"

Estatuario Polished 1600x3200
Estatuario Hond 1600x3200

2 DESIGNS / 2 DISEÑOS



WALL&FLOOR - Estatuario Hond 1200x3000 Rect.



**ARK
LAMI**
QUALITY DOESN'T FEAR TIME

WALL&FLOOR · Estuario Polished 1200x3000 Rect.

Suggested placement
Sugerencias de colocación



*6 different pieces/designs come mixed in boxes
*6 piezas diferentes se sirven aleatoriamente en las cajas

The pieces reflect each other as if they were an open book. Openbook included within the 6 graphics.
Las piezas se reflejan entre sí como si fueran un libro abierto. Openbook incluido dentro de las 6 gráficas.

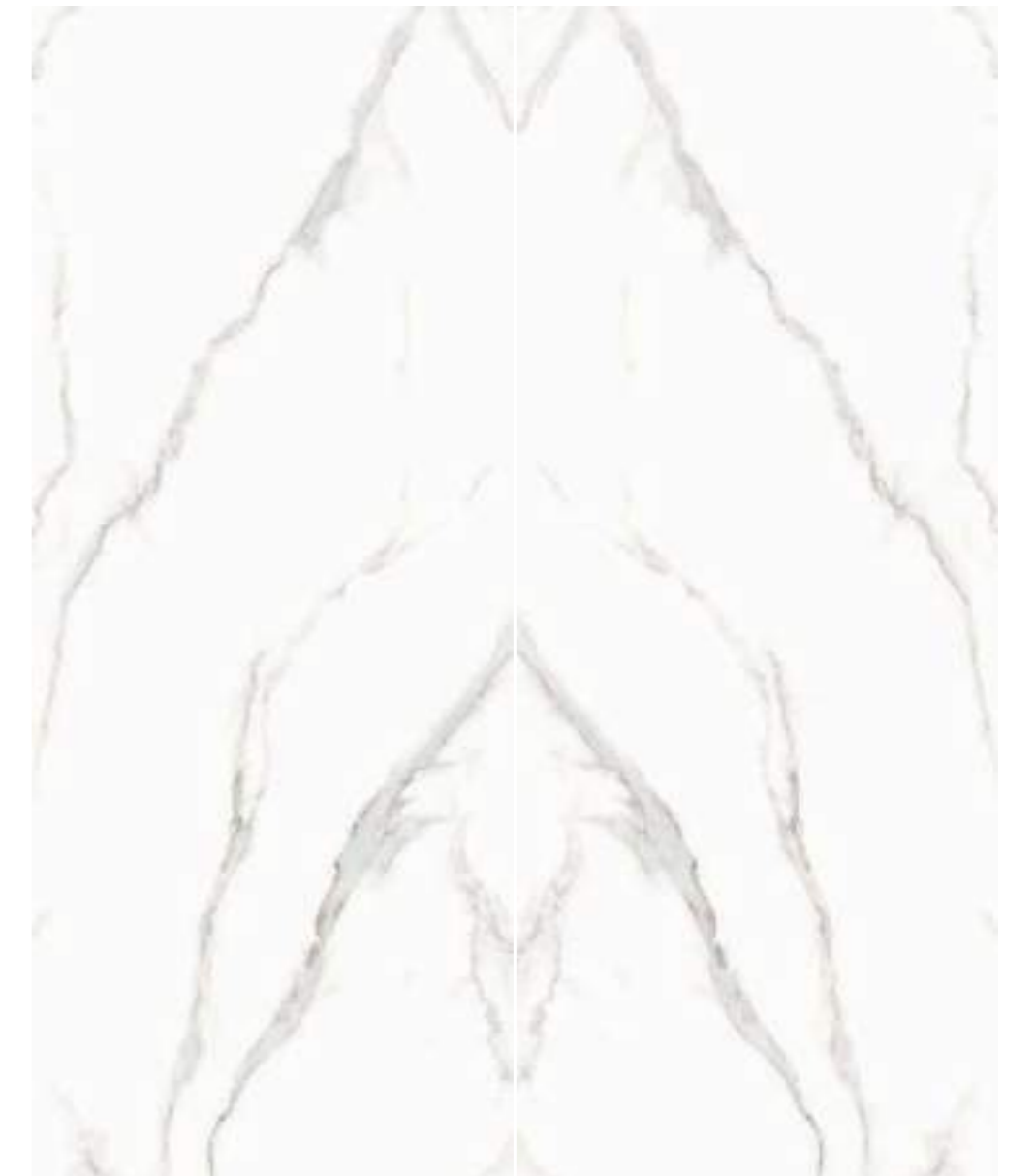

ESTATUARIO

ENDLESS, ENDMATCH & OPENBOOK

The pieces allow creating an infinite effect if they are successively placed in their original position by applying a 180 degree turn.
Las piezas permiten crear un efecto infinito si se colocan sucesivamente en su posición original aplicando un giro de 180°.



Suggested placement
Sugerencias de colocación



WALL - Estatuario Hond 1200x3000 Rect.

JURASSIC BLACK

ARK
LANT

▼ POLISHED
6 mm
▲ 1200x3000 mm/ 47,2"x118"
Jurassic Black Polished 1200x3000 Rect.
4 DESIGNS / 4 DISEÑOS





JURASSIC GOLD

ARK
LANT

▼ POLISHED
 6 mm
 ▲ 1200x3000 mm/ 47,2"x118"
 Jurassic Gold Polished 1200x3000 Rect.
 4 DESIGNS / 4 DISEÑOS



WALL · Jurassic Gold Polished 1200x3000 Rect. / Jurassic Black Polished 1200x3000 Rect.
 FLOOR · Jurassic Black Polished 1200x3000 Rect.



LILAC

ARK
LAM

▼
6 mm
▲

POLISHED

1200x3000 mm/ 47,2"x118"
Lilac Polished 1200x3000 Rect.

4 DESIGNS / 4 DISEÑOS

▼
12 mm
▲

HOND

1600x3200 mm/ 63"x126"
Lilac Hond 1600x3200

1 SINGLE DESIGN / 1 ÚNICO DISEÑO

▼
20 mm
▲

HOND

1600x3200 mm/ 63"x126"
Lilac Hond 1600x3200

1 SINGLE DESIGN / 1 ÚNICO DISEÑO



WALL · Lilac Polished 1200x3000 Rect.

ARK
LAMI

QUALITY DOESN'T FEAR TIME



WALL&FLOOR - Lilac Polished 1200x3000 Rect.

LILAC
•
ENDLESS

The different designs of the pieces allow creating an infinite effect by successively placing the pieces in their original position.
Los diferentes diseños de las piezas permiten crear un efecto infinito colocando sucesivamente las piezas en su posición original.

Suggested placement
Sugerencia de colocación



*4 different pieces/designs come mixed in boxes
*4 piezas diferentes se sirven aleatoriamente en las cajas



WALL&FLOOR - Lilac Polished 1200x3000 Rect.

MELBOURNE

ARK
LANT

▼
6 mm
▲
HOND
1200x3000 mm/ 47,2"x118"
Melbourne Hond 1200x3000 Rect.
4 DESIGNS / 4 DISEÑOS

▼
12 mm
▲
HOND
1600x3200 mm/ 63"x126"
Melbourne Hond 1600x3200
1 SINGLE DESIGN / 1 ÚNICO DISEÑO



WALL&FURNITURE · Melbourne Hond 1200x3000 Rect.

MELBOURNE

ENDLESS

The different designs of the pieces allow creating an infinite effect by successively placing the pieces in their original position.
Los diferentes diseños de las piezas permiten crear un efecto infinito colocando sucesivamente las piezas en su posición original.

Suggested placement
Sugerencia de colocación



*4 different pieces/designs come mixed in boxes
*4 piezas diferentes se sirven aleatoriamente en los cajones



WALL&FURNITURE · Melbourne Hond 1200x3000 Rect. / Pier17 Copper Natural 1200x3000 Rect.
FLOOR · Pier17 Copper Natural 1200x3000 Rect.

ARK
LANI
QUALITY DOESN'T FEAR TIME

MELBOURNE DECOR

ARK
LANT

▼
6 mm
▲

HOND

1200x3000 mm/ 47,2"x118"

Melbourne Decor Hond 1200x3000 Rect.

4 DESIGNS / 4 DISEÑOS



WALL · Melbourne Decor Hond 1200x3000 Rect.

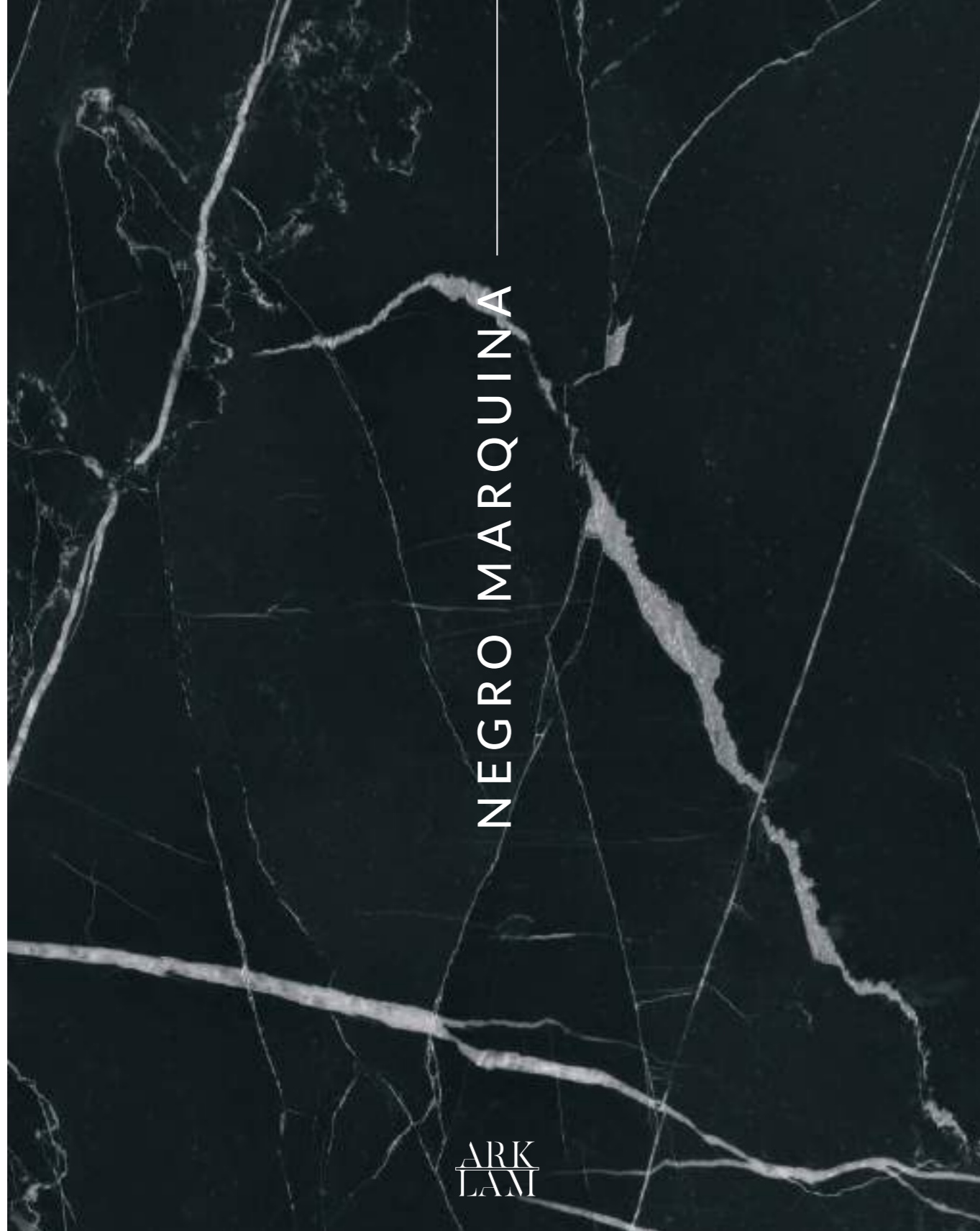

NEGRO MARQUINA

ARK
LANT

▼
6 mm
▲

POLISHED / SILK

1200x3000 mm/ 47,2"x118"
Negro Marquina Polished 1200x3000 Rect.
Negro Marquina Silk 1200x3000 Rect.

1000x3000 mm/ 39,4"x118"
Negro Marquina Polished 1000x3000 Rect.
Negro Marquina Silk 1000x3000 Rect.

4 DESIGNS / 4 DISEÑOS

▼
12 mm
▲

POLISHED / SILK

1600x3200 mm/ 63"x126"
Negro Marquina Polished 1600x3200
Negro Marquina Silk 1600x3200

1 SINGLE DESIGN / 1 ÚNICO DISEÑO



WALL&FLOOR - Negro Marquina Polished 1200x3000 Rect.

ONICE BLACK

ARK
LANT

▼ POLISHED
6 mm
▲ 1200x3000 mm/ 47,2"x118"
Onice Black Polished 1200x3000 Rect.

4 DESIGNS / 4 DISEÑOS



WALL · Onice Black Polished 1200x3000 Rect.
FLOOR · Alabama Oak Matt 59,5x119,2 Rect.

ARK
LAMI

QUALITY DOESN'T FEAR TIME



WALL&FLOOR · Onice Black Polished 1200x3000 Rect.

ONIX PEARL

ARK
LAMI

▼ POLISHED
6 mm
▲ 1200x3000 mm/ 47,2"x118"
Onix Pearl Polished 1200x3000 Rect.
6 DESIGNS / 6 DISEÑOS



FLOOR - Onix Pearl Polished 1200x3000 Rect.

ONIX BEIGE

ARK
LAMI

▼
6 mm
▲ POLISHED
1200x3000 mm/ 47,2"x118"
Onix Beige Polished 1200x3000 Rect.
6 DESIGNS/ 6 DISEÑOS





ONIX JADE

ARK
LANT

▼ POLISHED
6 mm
▲ 1200x3000 mm/ 47,2"x118"
Onix Jade Polished 1200x3000 Rect.
6 DESIGNS / 6 DISEÑOS



WALL · Onix Jade Polished 1200x3000 Rect.
FLOOR · Glaciar Polished 1000x3000 Rect.



WALL · Onix Jade Polished 1200x3000 Rect.
 FLOOR&FURNITURE · Onix Pearl Polished 1200x3000 Rect.

Suggested placement
 Sugerencias de colocación



*6 different pieces/designs come mixed in boxes
 *6 piezas diferentes se sirven aleatoriamente en las cajas

The pieces reflect each other as if they were an open book. Openbook included within the 6 graphics.
 Las piezas se reflejan entre sí como si fueran un libro abierto. Openbook incluido dentro de las 6 gráficas.



ONIX

ENDLESS, ENDMATCH & OPENBOOK

The pieces allow creating an infinite effect if they are successively placed in their original position by applying a 180 degree turn.
Las piezas permiten crear un efecto infinito si se colocan sucesivamente en su posición original aplicando un giro de 180°.



Suggested placement
Sugerencias de colocación



WALL&FLOOR - Onix Jade Polished 1200x3000 Rect.



ONIX TURQUOISE

ARK
LAMI

▼ POLISHED
 6 mm
 ▲ 1200x2600 mm/ 47,2"x103"
 Onix Turquoise Polished 1200x2600 Rect.
 2 DESIGNS / 2 DISEÑOS



WALL · Onix Turquoise Polished L 1200x2600 Rect. / Onix Turquoise Polished R 1200x2600 Rect.
 FLOOR · Glaciar Polished 1000x3000 Rect.
 FURNITURE · Vulcano Silk 1600x3200

ONIX TURQUOISE

OPEN BOOK

The pieces reflect each other as if they were an open book.
Las piezas se reflejan entre sí como si fueran un libro abierto.

Suggested placement
Sugerencia de colocación

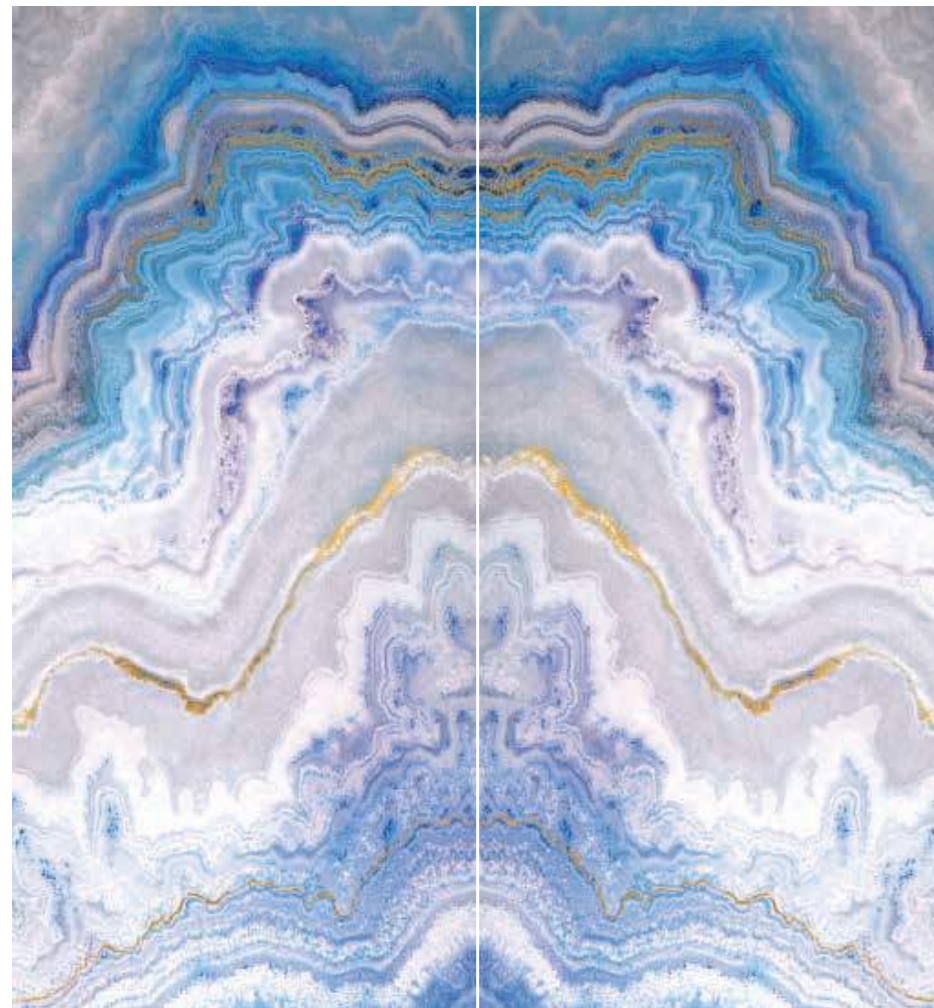

Onix Turquoise Polished Decor L 1200x2600 Rect.

Onix Turquoise Polished Decor R 1200x2600 Rect.



WALL · Onix Turquoise Polished L 1200x2600 Rect. / Onix Turquoise Polished R 1200x2600 Rect.
FLOOR · Glaciar Polished 1000x3000 Rect.

ARK
LANI
QUALITY DOESN'T FEAR TIME



PALISANDRO BLUE

ARK
LANT

- ▼ POLISHED
- 6 mm
- ▲ 1200x3000 mm/ 47,2"x118"
Palisandro Blue Polished 1200x3000 Rect.
- 1000x3000 mm/ 39,4"x118"
Palisandro Blue Polished 1000x3000 Rect.
- 1 SINGLE DESIGN / 1 ÚNICO DISEÑO



WALL&FLOOR - Palisandro Blue Polished 1200x3000 Rect.

PALISANDRO BLUE

ENDMATCH

The pieces's design allows to create an infinite effect alternating succesively one piece in the original position with another piece with a 180° rotation.

El diseño de la pieza permite crear un efecto infinito alternando sucesivamente una pieza en la posición original con otra pieza con un giro de 180°.

Suggested placement
Sugerencia de colocación



Original Position
Posición Original

Turn 180°
Giro 180°



ARK
LANI
QUALITY DOESN'T FEAR TIME

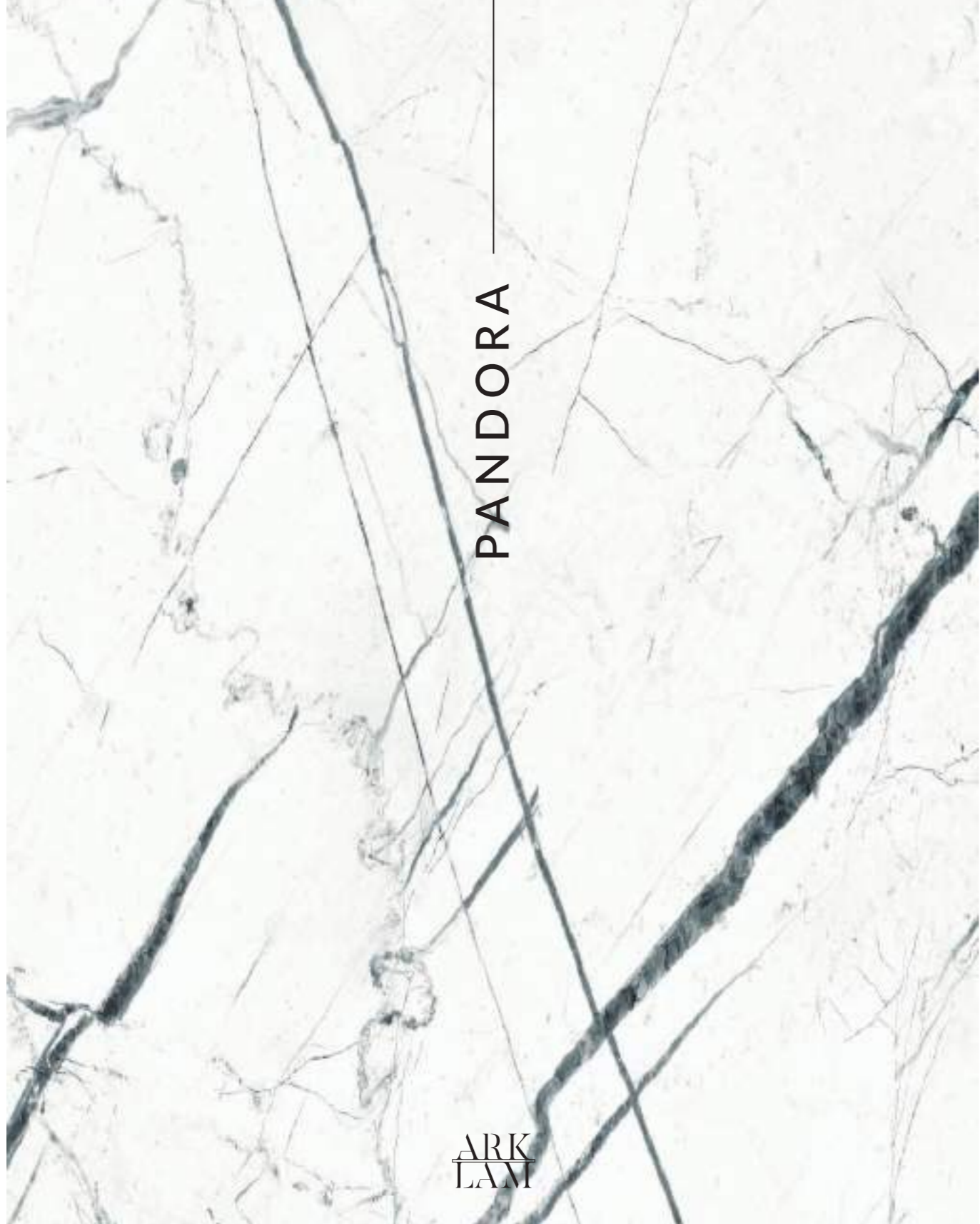

PANDORA

ARK
LAMI

▼
6 mm
▲

POLISHED / SILK

1200x3000 mm/ 47,2"x118"
Pandora Polished 1200x3000 Rect.
Pandora Silk 1200x3000 Rect.

1000x3000 mm/ 39,4"x118"
Pandora Polished 1000x3000 Rect.
Pandora Silk 1000x3000 Rect.

3 DESIGNS / 3 DISEÑOS



WALL&FLOOR - Pandora Silk 1200x3000 Rect.

ARK
LAMI

QUALITY DOESN'T FEAR TIME

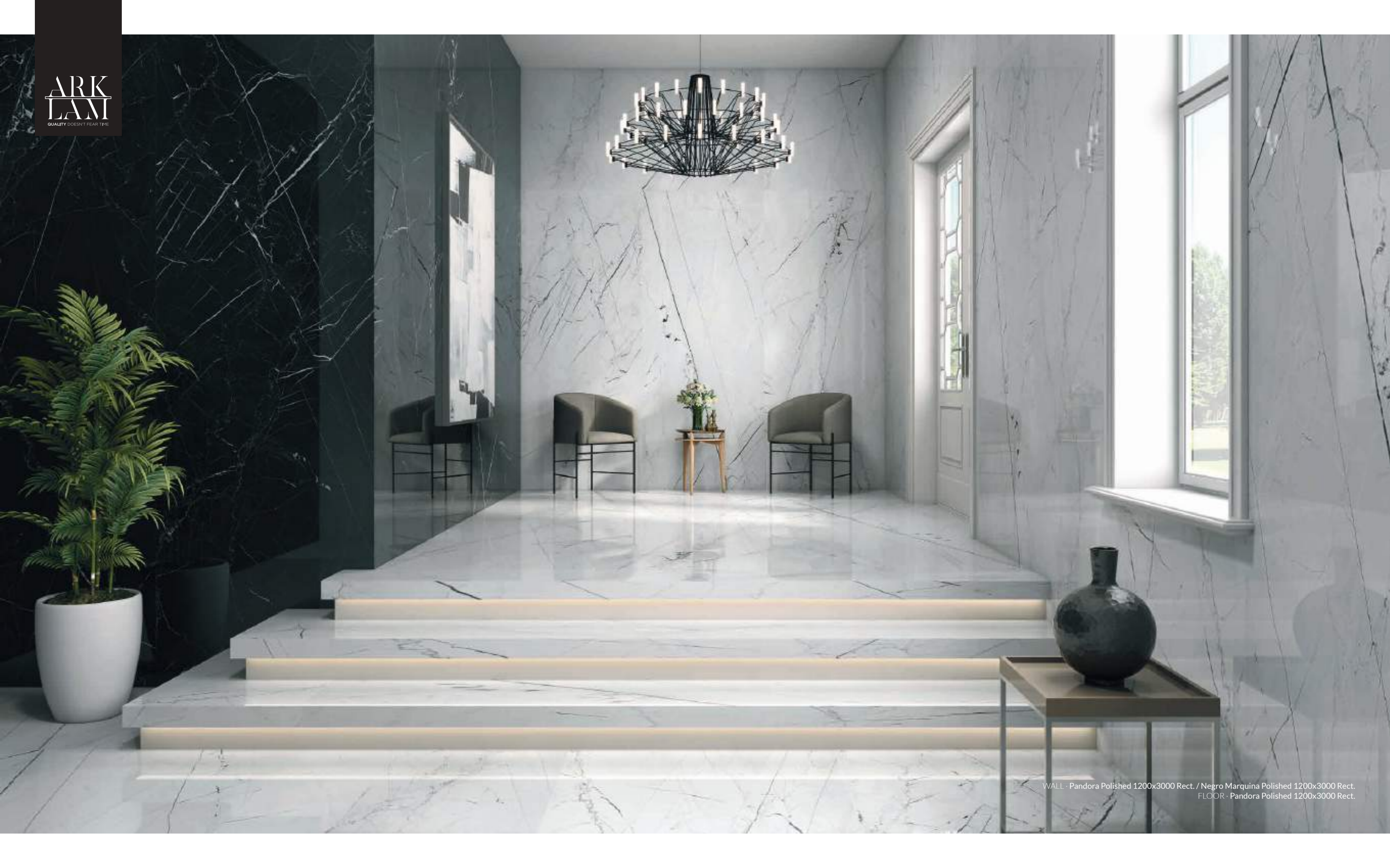

WALL - Pandora Polished 1200x3000 Rect. / Negro Marquina Polished 1200x3000 Rect.
FLOOR - Pandora Polished 1200x3000 Rect.



PATAGONIA

INNOVATIVE SOLUTIONS
 BACKLIGHT EFFECT
 TRANSLUCENT CERAMICS

ARK
 LAM

▼ POLISHED
 6 mm
 ▲ 1200x3000 mm/ 47,2"x118"
 Patagonia Gold Polished BL 1200x3000 Rect.
 3 DESIGNS / 3 DISEÑOS



WALL · Patagonia Gold Polished BL 1200x3000 Rect.

PATAGONIA

•
ENDLESS

The different designs of the pieces allow creating an infinite effect by succesively placing the pieces in their original position.
Los diferentes diseños de las piezas permiten crear un efecto infinito colocando sucesivamente las piezas en su posición original.

Suggested placement
Sugerencia de colocación



*3 different pieces/designs come mixed in boxes
*3 piezas diferentes se sirven aleatoriamente en las cajas



WALL&FLOOR · Patagonia Gold Polished BL 1200x3000 Rect.

ARK
LANI
QUALITY DOESN'T FEAR TIME





PORTOBELLO

ARK
LAMI

▼
6 mm
▲

POLISHED / SILK

1200x3000 mm / 47,2"x118"

Portobello Polished 1200x3000 Rect.
Portobello Silk 1200x3000 Rect.

1000x3000 mm / 39,4"x118"

Portobello Polished 1000x3000 Rect.
Portobello Silk 1000x3000 Rect.

8 DESIGNS / 8 DISEÑOS



WALL&FLOOR - Portobello Polished 1200x3000 Rect.

PULPIS NATURAL

ARK
LANT

▼
6 mm
▲

SILK

1200x3000 mm/ 47,2"x118"
Pulpis Natural Silk 1200x3000 Rect.

1000x3000 mm/ 39,4"x118"
Pulpis Natural Silk 1000x3000 Rect.

4 DESIGNS / 4 DISEÑOS

▼
12 mm
▲

SILK

1600x3200 mm/ 63"x126"
Pulpis Natural Silk 1600x3200

1 SINGLE DESIGN / 1 ÚNICO DISEÑO



WALL&FLOOR - Pulpis Natural Silk 1200x3000 Rect.

ROSA PERSIA

ARK
LANT

▼
6 mm
▲

POLISHED / HOND

1200x3000 mm/ 47,2"x118"

Rosa Persia Polished 1200x3000 Rect.
Rosa Persia Hond 1200x3000 Rect.

4 DESIGNS / 4 DISEÑOS

▼
12 mm
▲

HOND

1600x3200 mm/ 63"x126"

Rosa Persia Hond 1600x3200

1 SINGLE DESIGN / 1 ÚNICO DISEÑO

FLOOR - Rosa Persia Polished 1200x3000 Rect.

ARK
LAMI

QUALITY DOESN'T FEAR TIME



WALL · Rosa Persia Hond 1200x3000 Rect.
FLOOR · Rosa Persia Polished 1200x3000 Rect.

ROSA PERSIA

•
ENDLESS

The different designs of the pieces allow creating an infinite effect by successively placing the pieces in their original position.
Los diferentes diseños de las piezas permiten crear un efecto infinito colocando sucesivamente las piezas en su posición original.

Suggested placement
Sugerencia de colocación



*4 different pieces/designs come mixed in boxes
*4 piezas diferentes se sirven aleatoriamente en las cajas



WALL&FLOOR - Rosa Persia Hond 1200x3000 Rect.

ARK
LAMI
QUALITY DOESN'T FEAR TIME



SAHARA NOIR

ARK
LANT

▼
6 mm
▲

POLISHED / SILK

1200x3000 mm/ 47,2"x118"
Sahara Noir Polished 1200x3000 Rect.
Sahara Noir Silk 1200x3000 Rect.

1000x3000 mm/ 39,4"x118"
Sahara Noir Polished 1000x3000 Rect.
Sahara Noir Silk 1000x3000 Rect.

4 DESIGNS / 4 DISEÑOS

▼
12 mm
▲

HOND

1600x3200 mm/ 63"x126"
Sahara Noir Hond 1200x3600

1 SINGLE DESIGN / 1 ÚNICO DISEÑO



WALL - Sahara Noir Polished 1200x3000 Rect. / Omnia White Hond 1200x3000 Rect.
FLOOR - Sahara Noir Polished 1200x3000 Rect.

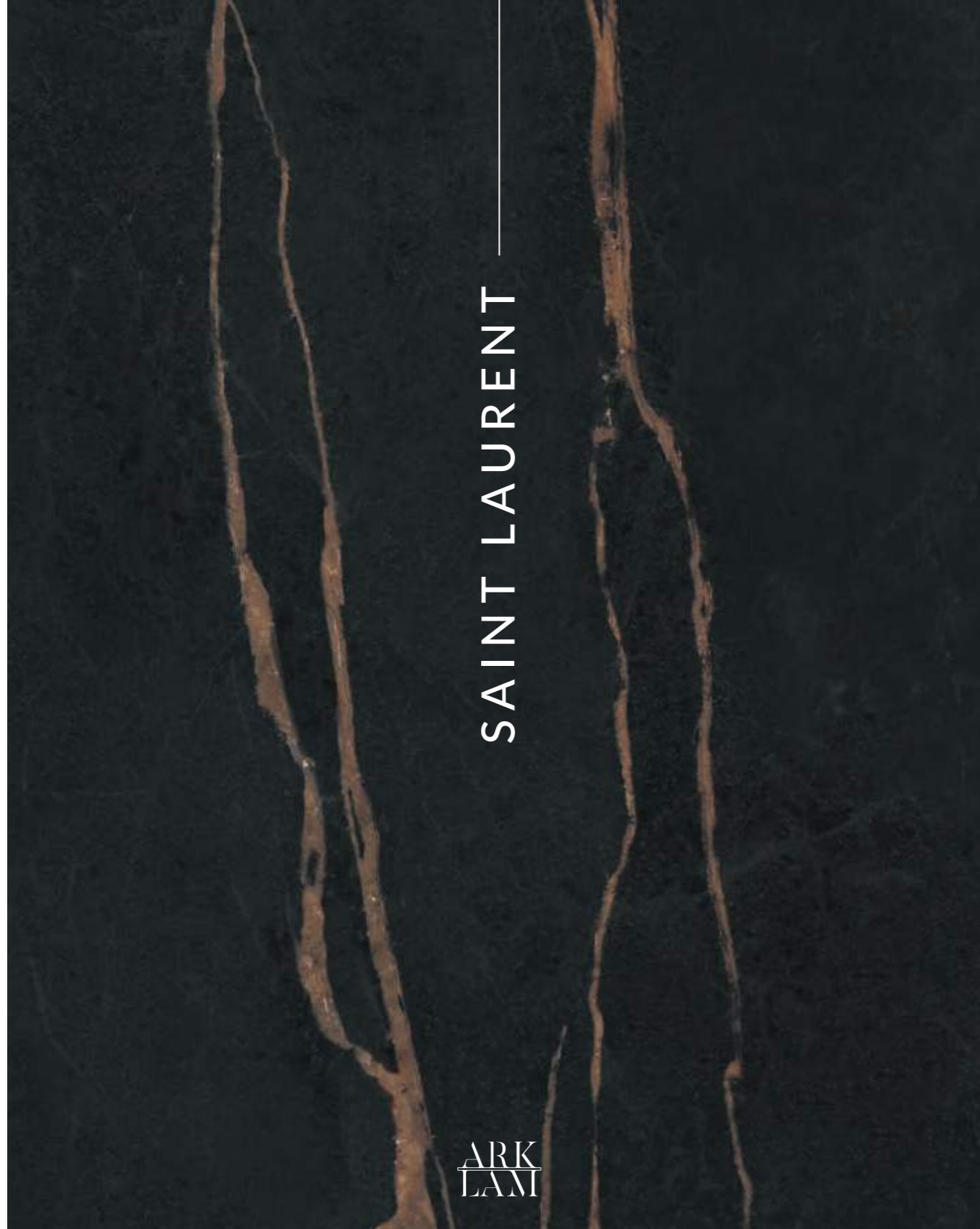

SAINT LAURENT

ARK
LANT

▼
6 mm
▲
NATURAL
1200x3000 mm/ 47,2"x118"
Saint Laurent Natural 1200x3000 Rect.
3 DESIGNS / 3 DISEÑOS

▼
12 mm
▲
NATURAL
1600x3200 mm/ 63"x126"
Saint Laurent Natural 1600x3200
2 DESIGNS / 2 DISEÑOS - OPENBOOK

▼
20 mm
▲
NATURAL
1600x3200 mm/ 63"x126"
Saint Laurent Natural 1600x3200
2 DESIGNS / 2 DISEÑOS - OPENBOOK



WALL - Saint Laurent Natural 1200x3000 Rect.

SAINT LAURENT

ENDLESS

The different designs of the pieces allow creating an infinite effect by successively placing the pieces in their original position.
Los diferentes diseños de las piezas permiten crear un efecto infinito colocando sucesivamente las piezas en su posición original.

Suggested placement
Sugerencia de colocación



*3 different pieces/designs come mixed in boxes
*3 piezas diferentes se sirven aleatoriamente en los cajones



WALL · Saint Laurent Natural 1200x3000 Rect.
FLOOR · Pietra Coral Sand Natural 1200x3000 Rect.

ARK
LAMI
QUALITY DOESN'T FEAR TIME



SYRAC

ARK
LAM

▼
6 mm
▲

POLISHED / HOND

1200x3000 mm/ 47,2"x118"
Syrac Polished 1200x3000 Rect.
Syrac Hond 1200x3000 Rect.

4 DESIGNS / 4 DISEÑOS

▼
12 mm
▲

HOND

1600x3200 mm/ 63"x126"
Syrac Hond 1600x3200

1 SINGLE DESIGN / 1 ÚNICO DISEÑO

▼
20 mm
▲

HOND

1600x3200 mm/ 63"x126"
Syrac Hond 1600x3200

1 SINGLE DESIGN / 1 ÚNICO DISEÑO



WALL - Syrac Hond 1200x3000 Rect.



SYRAC
•
ENDLESS

The different designs of the pieces allow creating an infinite effect by successively placing the pieces in their original position.
Los diferentes diseños de las piezas permiten crear un efecto infinito colocando sucesivamente las piezas en su posición original.

Suggested placement
Sugerencia de colocación



*4 different pieces/designs come mixed in boxes
*4 piezas diferentes se sirven aleatoriamente en las cajas



WALL&FLOOR · Syrac Hond 1200x3000 Rect.
FURNITURE · Jurassic Black Polished 1200x3000 Rect.

ARK
LANI
QUALITY DOESN'T FEAR TIME



TRAVERTINO GREY

ARK
LAMI

- ▼
6 mm
▲
- RIVER WASHED
 - 1200x3000 mm/ 47,2"x118"
Travertino Grey River Washed 1200x3000 Rect.
 - 1000x3000 mm/ 39,4"x118"
Travertino Grey River Washed 1000x3000 Rect.
 - 3 DESIGNS / 3 DISEÑOS



WALL&FLOOR - Travertino Grey River Washed 1200x3000 Rect.

TRAVERTINE NAVONA

ARK
LAMI

▼
6 mm
▲

HOND
1200x3000 mm/ 47,2"x118"
Travertine Navona Hond 1200x3000 Rect.
6 DESIGNS / 6 DISEÑOS



WALL · Travertine Navona Hond 1200x3000 Rect.

TRAVERTINE NAVONA

•
VEIN CUT & ENDLESS

The different designs of the pieces allow creating an infinite effect by successively placing the pieces in their original position.
Los diferentes diseños de las piezas permiten crear un efecto infinito colocando sucesivamente las piezas en su posición original.

Suggested placement
Sugerencia de colocación

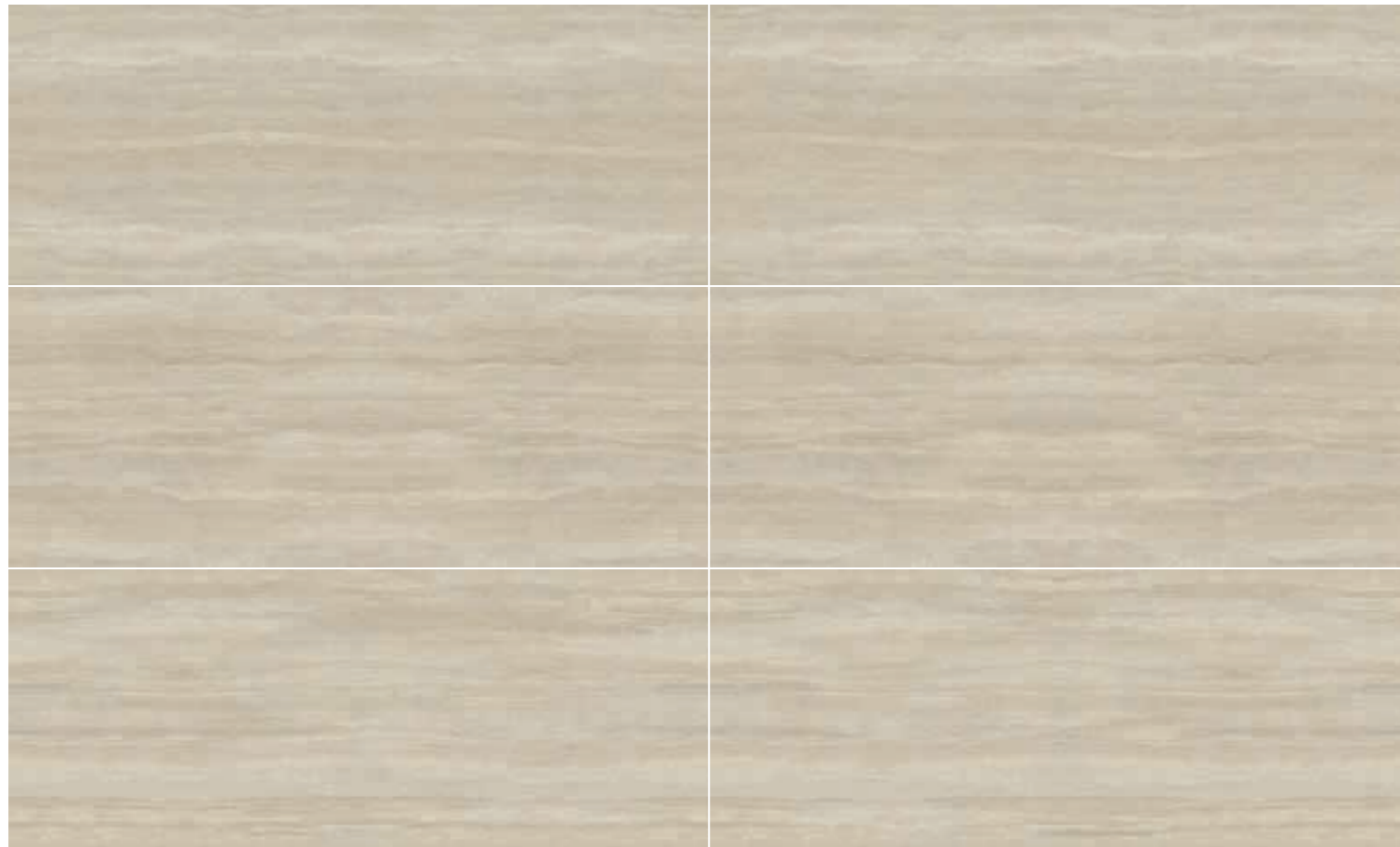

*6 different patterns vein cut & endless.
*6 diseños diferentes con continuidad.



WALL&FLOOR - Travertine Navona Hond 1200x3000 Rect.

ARK
LAMI
QUALITY DOESN'T FEAR TIME



ARK
LAN
QUALITY DOESN'T FEAR TIME

CONCRETE&STONE COLLECTION

COLLECTION CEMENTOS Y PIEDRAS

ATRIUM BEIGE

ARK
LAMI

▼
6 mm
▲

NATURAL
1200x3000 mm/ 47,2"x118"
Atrium Beige Natural 1200x3000 Rect.
3 DESIGNS / 3 DISEÑOS



ATRIUM PEARL

ARK
LAMI

▼
6 mm
▲

NATURAL
1200x3000 mm/ 47,2"x118"
Atrium Pearl Natural 1200x3000 Rect.
3 DESIGNS / 3 DISEÑOS



WALL · Atrium Pearl Natural 1200x3000 Rect.
FLOOR · Atrium Anthracite Natural 1200x3000 Rect.

ATRIUM GREY

ARK
LAMI

▼
6 mm
▲

NATURAL
1200x3000 mm/ 47,2"x118"
Atrium Grey Natural 1200x3000 Rect.
3 DESIGNS / 3 DISEÑOS



WALL · Atrium Grey Natural 1200x3000 Rect.
FLOOR · Atrium Anthracite Natural 1200x3000 Rect.

ATRIUM ANTHRACITE

ARK
LANT

▼
6 mm
▲

NATURAL
1200x3000 mm/ 47,2"x118"
Atrium Anthracite Natural 1200x3000 Rect.
3 DESIGNS / 3 DISEÑOS



WALL&FLOOR · Atrium Anthracite Natural 1200x3000 Rect.

AVENUE WHITE

ARK
LAMI

▼
6 mm
▲

SILK
1200x3000 mm/ 47,2"x118"
Avenue White Silk 1200x3000 Rect.
4 DESIGNS / 4 DISEÑOS



FLOOR · Avenue White Silk 1200x3000 Rect.

AVENUE ASH

ARK
LAMI

▼
6 mm
▲

SILK
1200x3000 mm/ 47,2"x118"
Avenue Ash Silk 1200x3000 Rect.
4 DESIGNS / 4 DISEÑOS

AVENUE TAUPE

ARK
LANT

▼
6 mm
▲

SILK
1200x3000 mm/ 47,2"x118"
Avenue Taupe Silk 1200x3000 Rect.
4 DESIGNS / 4 DISEÑOS



WALL&FLOOR · Avenue Taupe Silk 1200x3000 Rect.

AVENUE GRAPHITE

ARK
LANT

▼
6 mm
▲

SILK
1200x3000 mm/ 47,2"x118"
Avenue Graphite Silk 1200x3000 Rect.
4 DESIGNS / 4 DISEÑOS



WALL · Avenue White Silk 1200x3000 Rect. / Avenue Graphite Silk 1200x3000 Rect.
FLOOR · Avenue Graphite Silk 1200x3000 Rect.

BATEIG BLUE

ARK
LAM

▼
6 mm
▲

NATURAL
1200x3000 mm/ 47,2"x118"
Bateig Blue Natural 1200x3000 Rect.
3 DESIGNS / 3 DISEÑOS

▼
12 mm
▲

NATURAL
1600x3200 mm/ 63"x126"
Bateig Blue Natural 1600x3200
1 SINGLE DESIGN / 1 ÚNICO DISEÑO



WALL · Bateig Blue Natural 1200x3000 Rect.
FLOOR · Pier17 Copper Natural 1000x3000 Rect.



BATEIG VERONA

ARK
LAMI

▼
6 mm
▲
NATURAL
1200x3000 mm/ 47,2"x118"
Bateig Verona Natural 1200x3000 Rect.
3 DESIGNS / 3 DISEÑOS

▼
12 mm
▲
NATURAL
1600x3200 mm/ 63"x126"
Bateig Verona Natural 1600x3200
1 SINGLE DESIGN / 1 ÚNICO DISEÑO



WALL - Bateig Verona Natural 1200x3000 Rect.



CHROMATICA BLUE

ARK
LANT

▼
6 mm
▲

SILK
1200x3000 mm/ 47,2"x118"
Chromatica Blue Silk 1200x3000 Rect.
2 DESIGNS / 2 DISEÑOS



WALL · Phoenix Blue Silk 1200x3000 Rect.
FLOOR · Chromatica Blue Silk 1200x3000 Rect.

PHOENIX BLUE

ARK
LANT

▼
6 mm
▲

SILK
1200x3000 mm/ 47,2"x118"
Phoenix Blue Silk 1200x3000 Rect.
2 DESIGNS / 2 DISEÑOS



WALL · Phoenix Blue Silk 1200x3000 Rect.
FLOOR · Chromatica Blue Silk 1200x3000 Rect.

PHOENIX BLUE

ENDLESS

The different designs of the pieces allow creating an infinite effect by successively placing the pieces in their original position.

Los diferentes diseños de las piezas permiten crear un efecto infinito colocando sucesivamente las piezas en su posición original.

Suggested placement
Sugerencia de colocación



*2 different pieces/designs come mixed in boxes
*2 piezas diferentes se sirven aleatoriamente en las cajas



WALL · Phoenix Blue Silk 1200x3000 Rect.
FLOOR · Irati Oak Matt 25x150 Rect.

ARK
LANI
QUALITY DOESN'T FEAR TIME

COPENHAGUEN WHITE

ARK
LAMI

▼
6 mm
▲

SILK
1500x2600 mm/ 59"x103"
Copenhaguen White Silk 1500x2600 Rect.
8 DESIGNS / 8 DISEÑOS



WALL&FLOOR · Copenhaguen White Silk 1500x2600 Rect.
FURNITURE · Negro Marquina Polished 1600x3200 / Pier17 Copper Natural 1200x3000 Rect.

GRIS LEVANTE

ARK
LAMI

▼
6 mm
▲
NATURAL
1200x3000 mm/ 47,2"x118"
Gris Levante Natural 1200x3000 Rect.
3 DESIGNS / 3 DISEÑOS

▼
12 mm
▲
NATURAL
1600x3200 mm/ 63"x126"
Gris Levante Natural 1600x3200
1 SINGLE DESIGN / 1 ÚNICO DISEÑO



FURNITURE & WALL · Gris Levante Natural 1200x3000 Rect.

GRIS LEVANTE

ENDLESS

The different designs of the pieces allow creating an infinite effect by succesively placing the pieces in their original position.
Los diferentes diseños de las piezas permiten crear un efecto infinito colocando sucesivamente las piezas en su posición original.

Suggested placement
Sugerencia de colocación



*3 different pieces/designs come mixed in boxes
*3 piezas diferentes se sirven aleatoriamente en las cajas



WALL&FLOOR - Gris Levante Natural 1200x3000 Rect.

LONDRA BLACK

ARK
LANT

- ▼
6 mm
▲
- SILK**
1200x3000 mm/ 47,2"x118"
Londra Black Silk 1200x3000 Rect.
- 1000x3000 mm/ 39,4"x118"
Londra Black Silk 1000x3000 Rect.
- 4 DESIGNS / 4 DISEÑOS



FLOOR - Londra Black Silk 1200x3000 Rect.
FURNITURE - Syrac Hond 1600x3200 / Volakas Silk 1600x3200 / Sahara Noir Silk 1200x3000 Rect.

LONDRA GREY

ARK
LANT

▼
6 mm
▲

SILK
1200x3000 mm/ 47,2"x118"
Londra Grey Silk 1200x3000 Rect.
4 DESIGNS / 4 DISEÑOS



MANHATTAN WHITE

ARK
LANT

- ▼
6 mm
▲
- SILK
1200x3000 mm/ 47,2"x118"
Manhattan White Silk 1200x3000 Rect.
- 1000x3000 mm/ 39,4"x118"
Manhattan White Silk 1000x3000 Rect.
- 8 DESIGNS / 8 DISEÑOS



WALL&FLOOR · Manhattan White Silk 1200x3000 Rect.

MANHATTAN BEIGE

ARK
LAMI

▼
6 mm
▲

SILK

1200x3000 mm/ 47,2"x118"
Manhattan Beige Silk 1200x3000 Rect.

1000x3000 mm/ 39,4"x118"
Manhattan Beige Silk 1000x3000 Rect.

8 DESIGNS / 8 DISEÑOS



WALL&FLOOR · Manhattan Beige Silk 1200x3000 Rect.

MANHATTAN GREY

ARK
LANT

▼
6 mm
▲

SILK

1200x3000 mm/ 47,2"x118"
Manhattan Grey Silk 1200x3000 Rect.

1000x3000 mm/ 39,4"x118"
Manhattan Grey Silk 1000x3000 Rect.

8 DESIGNS / 8 DISEÑOS

▼
12 mm
▲

SILK

1600x3200 mm/ 63"x126"
Manhattan Grey Silk 1600x3200

1 SINGLE DESIGN / 1 ÚNICO DISEÑO



WALL&FLOOR - Manhattan Grey Silk 1200x3000 Rect.



▼ POLISHED / NATURAL
6 mm
▲
1200x3000 mm/ 47,2"x118"
Mystic Grey Polished 1200x3000 Rect.
Mystic Grey Natural 1200x3000 Rect.
3 DESIGNS / 3 DISEÑOS



WALL&FLOOR - Mystic Grey Natural 1200x3000 Rect.

MYSTIC GREY

ENDLESS

The different designs of the pieces allow creating an infinite effect by successively placing the pieces in their original position.
Los diferentes diseños de las piezas permiten crear un efecto infinito colocando sucesivamente las piezas en su posición original.

Suggested placement
Sugerencia de colocación



*3 different pieces/designs come mixed in boxes
*3 piezas diferentes se sirven aleatoriamente en las cajas



WALL&FLOOR - Mystic Grey Polished 1200x3000 Rect.

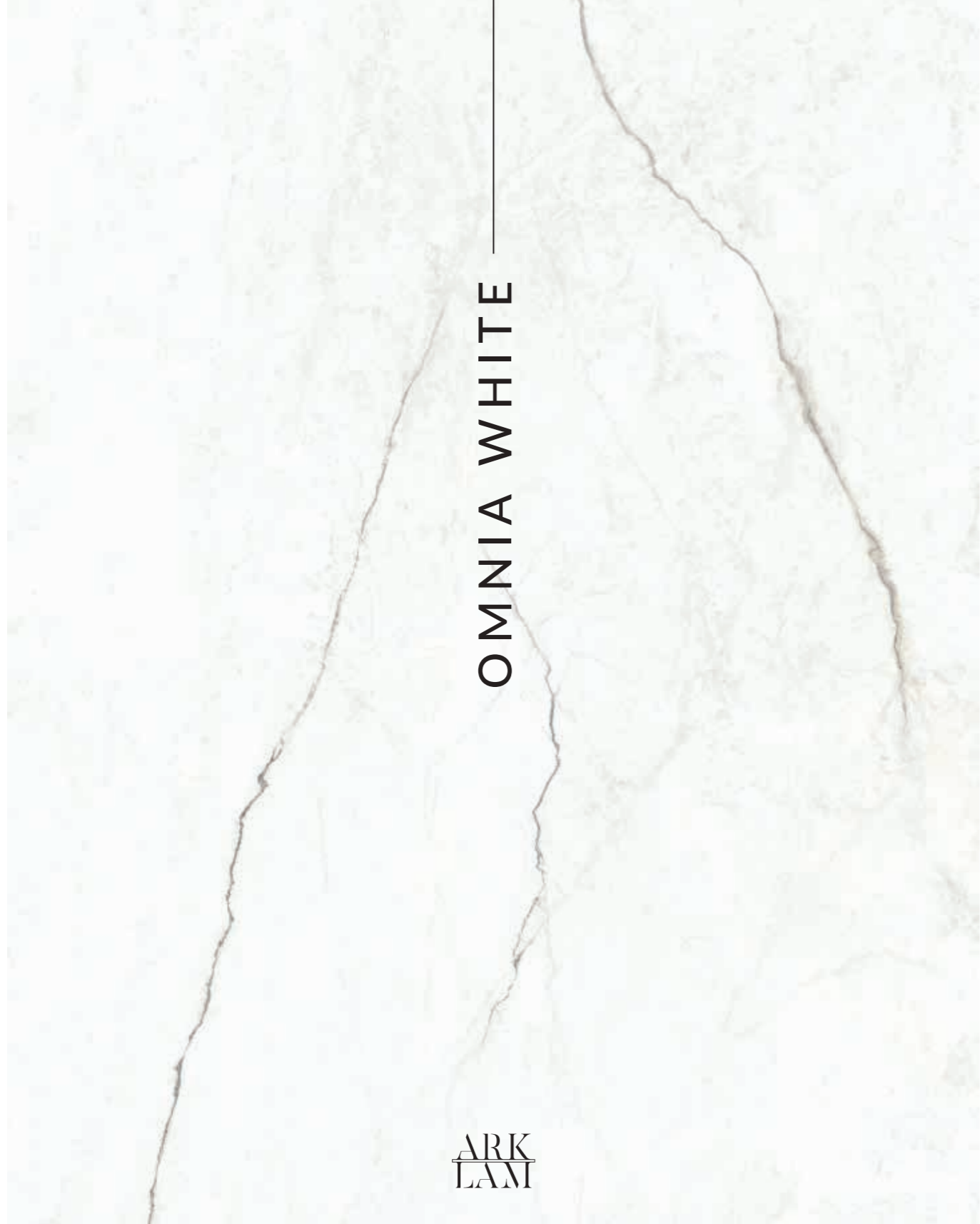

▼
6 mm
▲

POLISHED / HOND
1200x3000 mm/ 47,2"x118"
Omnia White Polished 1200x3000 Rect.
Omnia White Hond 1200x3000 Rect.
3 DESIGNS / 3 DISEÑOS



WALL&FLOOR - Omnia White Polished 1200x3000 Rect.

OMNIA WHITE

ENDLESS

The different designs of the pieces allow creating an infinite effect by successively placing the pieces in their original position.
Los diferentes diseños de las piezas permiten crear un efecto infinito colocando sucesivamente las piezas en su posición original.

Suggested placement
Sugerencia de colocación



*3 different pieces/designs come mixed in boxes
*3 piezas diferentes se sirven aleatoriamente en las cajas



WALL&FLOOR - Omnia White Hond 1200x3000 Rect.

ARK
LANI
QUALITY DOESN'T FEAR TIME

PIER17 COPPER

ARK
LANT

▼
6 mm
▲

NATURAL
1200x3000 mm/ 47,2"x118"
Pier17 Copper Natural 1200x3000 Rect.
8 DESIGNS / 8 DISEÑOS



WALL&FLOOR - Pier17 Copper Natural 1200x3000 Rect.

PIER17 ZINC

ARK
LANT

▼
6 mm
▲

NATURAL
1200x3000 mm/ 47,2"x118"
Pier17 Zinc Natural 1200x3000 Rect.
8 DESIGNS / 8 DISEÑOS

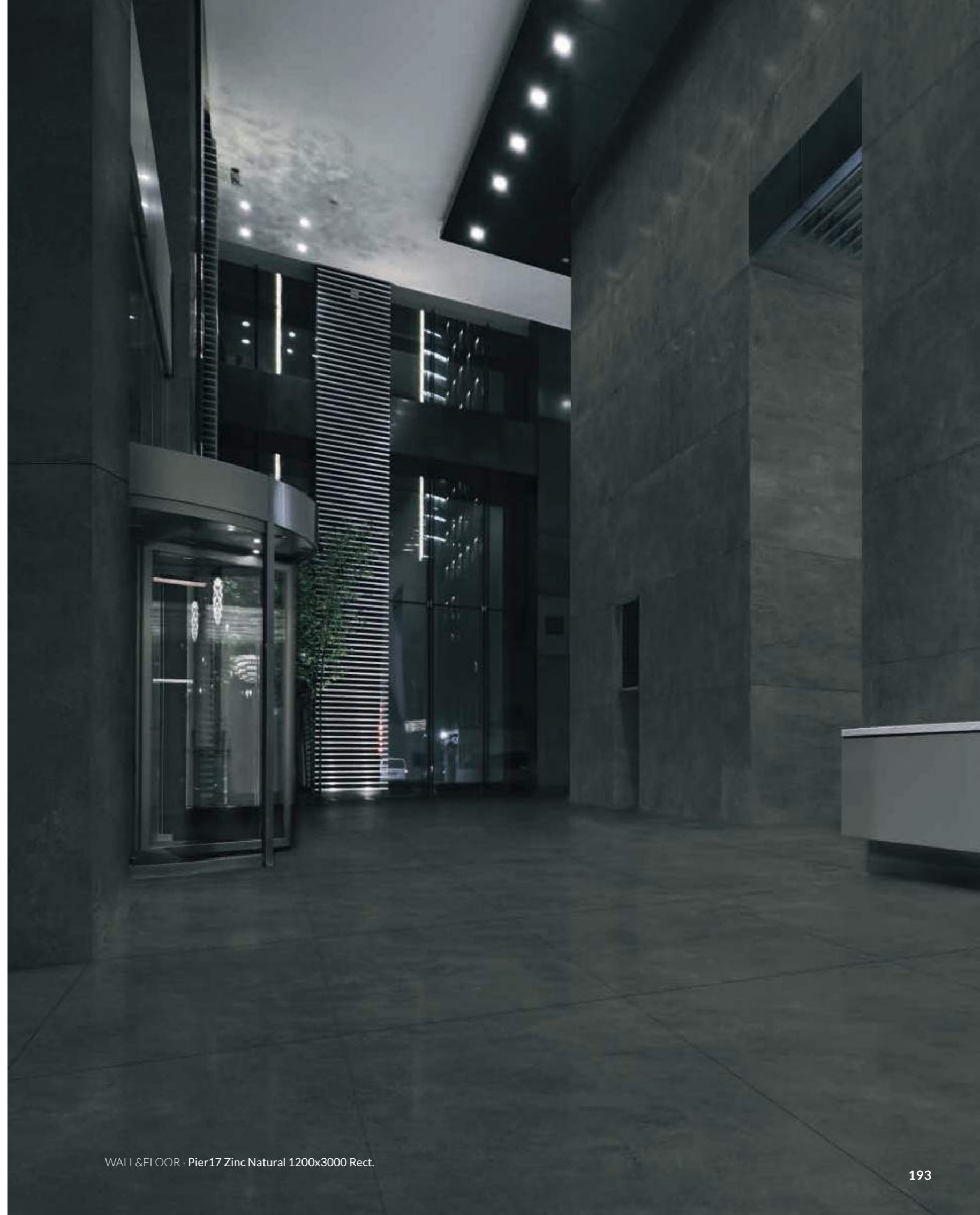

WALL&FLOOR - Pier17 Zinc Natural 1200x3000 Rect.

PIETRA CORAL

ARK
LAMI

- ▼
6 mm
▲
- NATURAL
 - 1200x3000 mm/ 47,2"x118"
Pietra Coral Natural 1200x3000 Rect.
 - 1000x3000 mm/ 39,4"x118"
Pietra Coral Natural 1000x3000 Rect.
- 3 DESIGNS / 3 DISEÑOS



WALL&FLOOR - Pietra Coral Natural 1200x3000 Rect.

PIETRA CORAL PEARL

ARK
LANT

▼
6 mm
▲

NATURAL
1200x3000 mm/ 47,2"x118"
Pietra Coral Pearl Natural 1200x3000 Rect.
3 DESIGNS / 3 DISEÑOS



WALL&FLOOR - Pietra Coral Pearl Natural 1200x3000 Rect.

PIETRA CORAL SAND

ARK
LAMI

▼
6 mm
▲

NATURAL
1200x3000 mm/ 47,2"x118"
Pietra Coral Sand Natural 1200x3000 Rect.
3 DESIGNS / 3 DISEÑOS

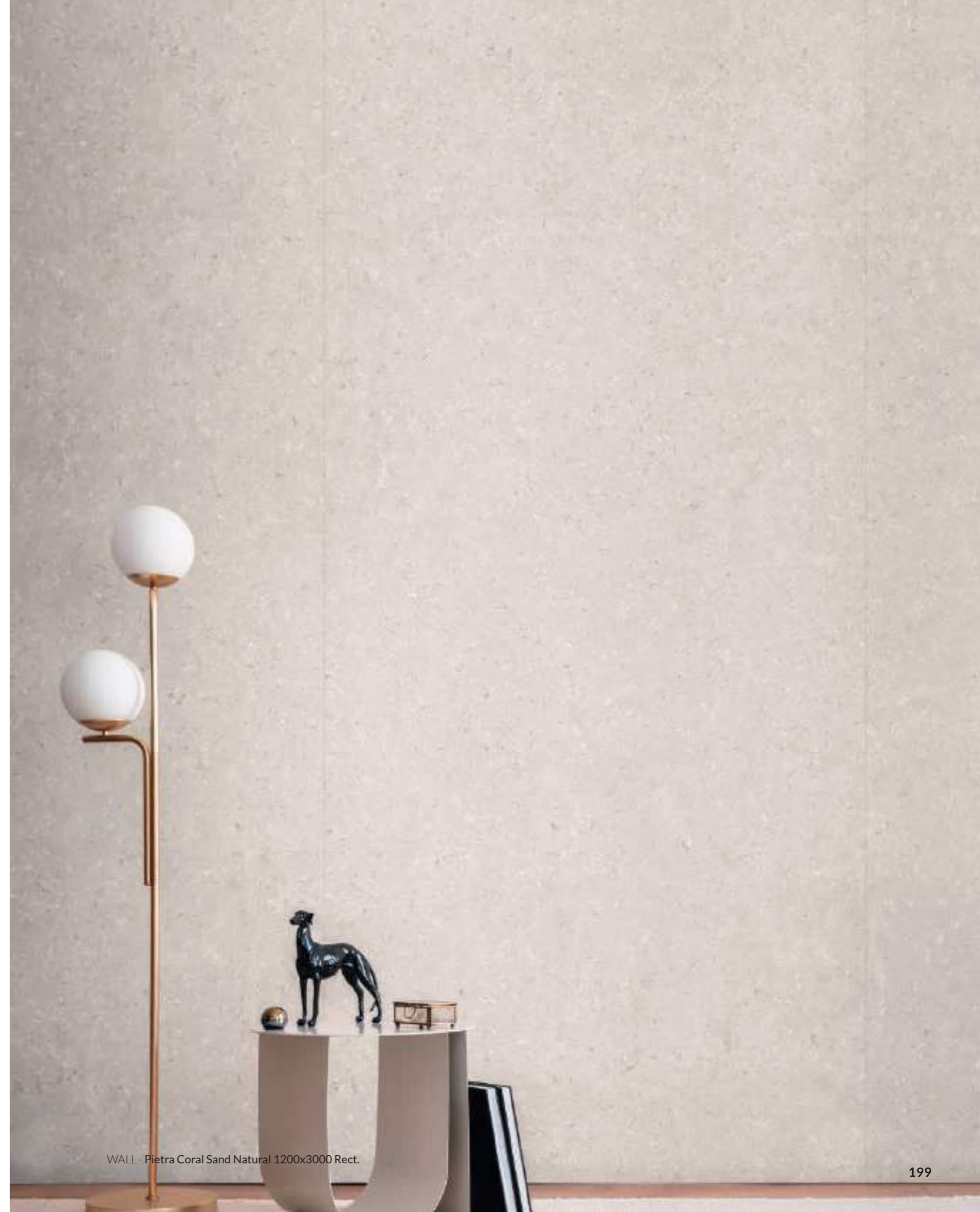

WALL · Pietra Coral Sand Natural 1200x3000 Rect.



POMPEIA

ARK
LANT

- ▼
6 mm
▲
- SILK
1200x3000 mm/ 47,2"x118"
Pompeia Silk 1200x3000 Rect.
- 1000x3000 mm/ 39,4"x118"
Pompeia Silk 1000x3000 Rect.
- 8 DESIGNS / 8 DISEÑOS



FLOOR · Pompeia Silk 1200x3000 Rect.



POMPEIA DECOR

ARK
LANT

▼
6 mm
▲

SILK
1000x3000 mm/ 39,4"x118"
Pompeia Decor Silk 1000x3000 Rect.
2 DESIGNS / 2 DISEÑOS



WALL · Pompeia Silk 1200x3000 Rect. / Pompeia Decor Silk 1000x3000 Rect.
FLOOR · Pompeia Silk 1200x3000 Rect.

POMPEIA DECOR

ENDLESS

The different designs of the pieces allow creating an infinite effect by successively placing the pieces in their original position.

Los diferentes diseños de las piezas permiten crear un efecto infinito colocando sucesivamente las piezas en su posición original.

Suggested placement
Sugerencia de colocación

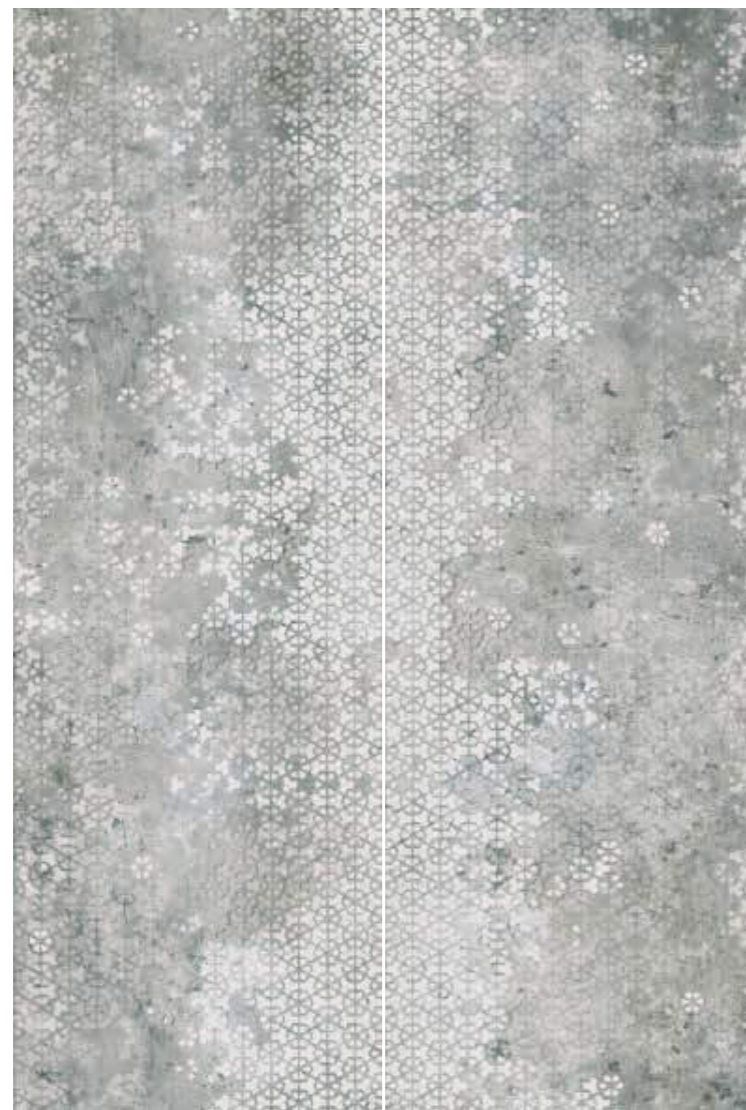

*2 different pieces/designs come mixed in boxes
*2 piezas diferentes se sirven aleatoriamente en las cajas



WALL · Pompeia Silk 1200x3000 Rect. / Pompeia Decor Silk 1000x3000 Rect.
FLOOR · Pompeia Silk 1200x3000 Rect.

ARK
LANI
QUALITY DOESN'T FEAR TIME

PORTLAND

ARK
LAMI

▼
6 mm
▲

NATURAL
1200x3000 mm/ 47,2"x118"
Portland Stone Natural 1200x3000 Rect.
5 DESIGNS / 5 DISEÑOS



WALL · Portland Stone Natural 1200x3000 Rect.

PORTLAND STONE

1200 x 3000

Suggested placement
Sugerencia de colocación



The authenticity of natural stone

Introducing Portland Stone, a collection produced using cutting-edge techniques, where touch, effect and texture take centre stage in a hyper-realistic finish of this stone.

In harmony with nature, Portland Stone offers a natural canvas that invites you to dream, transforming any space into a setting of neutral elegance. From a business environment to the intimacy of a home, this collection redefines standards, providing an experience that is both unique and inspirational.

Utilising cutting-edge technology **Hyper Tech**, this collection captivates with its natural finish, emphasising the stone's authenticity, surpassing conventional limits and offering boundless possibilities. Portland Stone becomes an aesthetic narrative where each piece showcases the strength and intrinsic beauty of limestone.

La autenticidad de la piedra Natural

Presentamos Portland Stone, una colección realizada con técnicas de vanguardia, donde tacto, efecto y textura protagonizan un acabado hiperrealista de esta piedra.

En sintonía con la naturaleza, Portland Stone se convierte en un lienzo neutro que invita a soñar, transformando cualquier espacio en un escenario de elegancia neutral. Desde el entorno comercial hasta la intimidad de la residencia, esta colección redefine los estándares, brindando una experiencia única e inspiradora.

Con una nueva tecnología de vanguardia **Hyper Tech**, esta colección seduce por su acabado natural que destaca la autenticidad de la piedra, trascendiendo límites convencionales y ofreciendo infinitas posibilidades. Portland Stone se convierte en una narrativa estética donde cada pieza exhibe la resistencia y la belleza intrínseca de la piedra caliza.



WALL&FLOOR · Portland Stone Natural 1200x3000 Rect.

ARK
LAMI
QUALITY DOESN'T FEAR TIME

ARK
LAMI

QUALITY DOESN'T FEAR TIME



WALL&FLOOR - Portland Stone Natural 1200x3000 Rect.

SEVEN BEIGE

ARK
LAMI

▼
6 mm
▲

NATURAL
1200x2800 mm/ 47,2"x110"
Seven Beige Natural 1200x2800 Rect.
5 DESIGNS/5 DISEÑOS



WALL&FLOOR - Seven Beige Natural 1200x2800 Rect.

GARLAND BEIGE

ARK
LAMI

▼
6 mm
▲

NATURAL
1200x2800 mm/ 47,2"x110"
Garland Beige Natural 1200x2800 Rect.
5 DESIGNS / 5 DISEÑOS



WALL: Garland Beige Natural 1200x2800 Rect.

SEVEN SAND

ARK
LAMI

▼
6 mm
▲

NATURAL

1200x2800 mm/ 47,2"x110"
Seven Sand Natural 1200x2800 Rect.

5 DESIGNS / 5 DISEÑOS

GARLAND SAND

ARK
LAMI

▼
6 mm
▲

NATURAL
1200x2800 mm/ 47,2"x110"
Garland Sand Natural 1200x2800 Rect.
5 DESIGNS / 5 DISEÑOS



WALL · Garland Sand Natural 1200x2800 Rect. / Seven Sand Natural 1200x2800 Rect.
FLOOR · Seven Sand Natural 1200x2800 Rect.

SEVEN HAZELNUT

ARK
LAMI

▼
6 mm
▲
NATURAL
1200x2800 mm/ 47,2"x110"
Seven Hazelnut Natural 1200x2800 Rect.
5 DESIGNS / 5 DISEÑOS

▼
12 mm
▲
NATURAL
1600x3200 mm/ 63"x126"
Seven Hazelnut Natural 1600x3200
1 SINGLE DESIGN / 1 ÚNICO DISEÑO



WALL&FLOOR - Seven Hazelnut Natural 1200x2800 Rect.

GARLAND HAZELNUT

ARK
LAMI

▼
6 mm
▲

NATURAL
1200x2800 mm/ 47,2"x110"
Garland Hazelnut Natural 1200x2800 Rect.
5 DESIGNS / 5 DISEÑOS

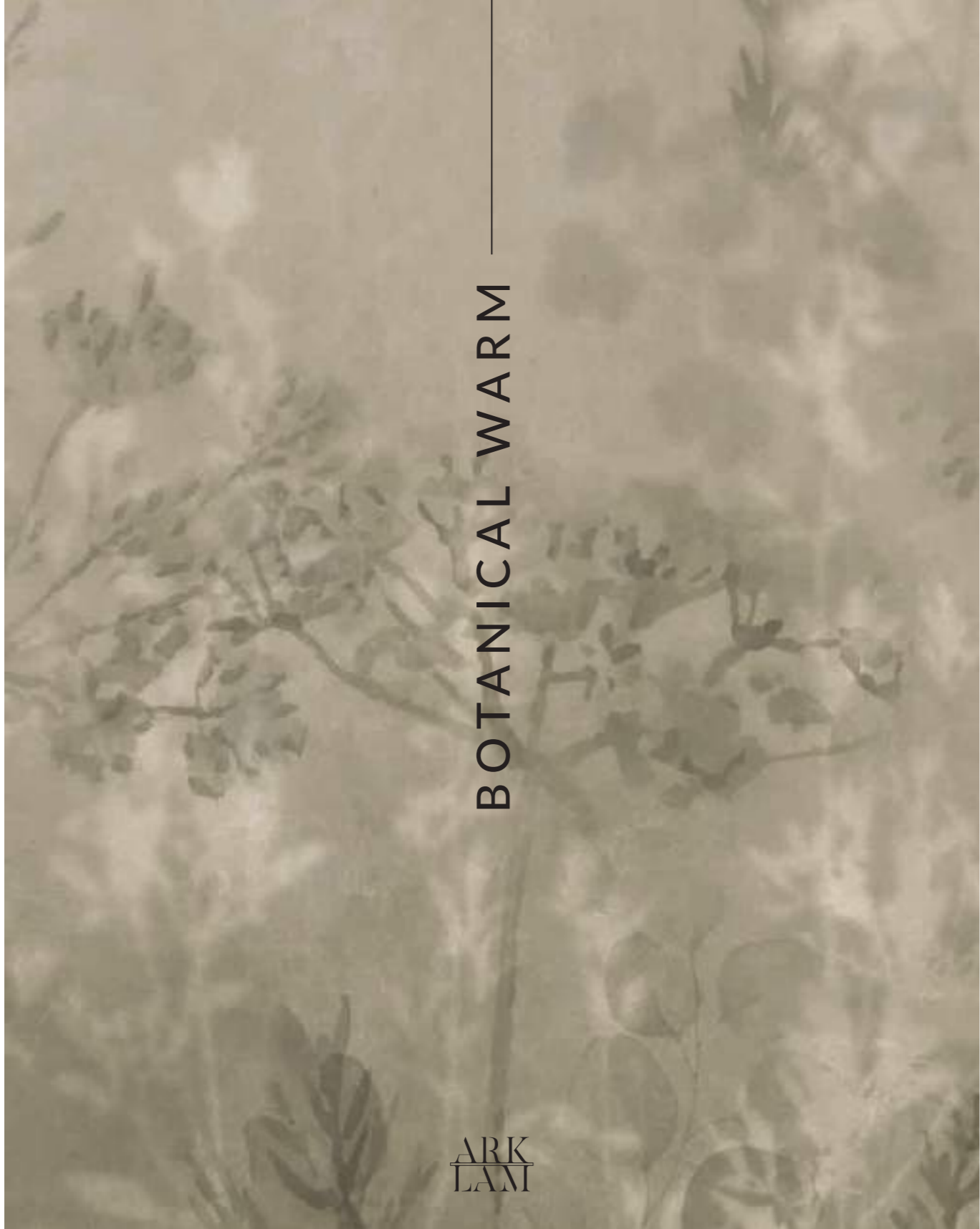

BOTANICAL WARM

ARK
LAMI

▼
6 mm
▲

NATURAL
1200x2800 mm/ 47,2"x110"
Botanical Warm Natural 1200x2800 Rect.
2 DESIGNS / 2 DISEÑOS



WALL · Botanical Warm Natural 1200x2800 Rect.
FLOOR · Irati Oak Matt 25x150 Rect.

BOTANICAL WARM

ENDLESS

The different designs of the pieces allow creating an infinite effect by successively placing the pieces in their original position.

Los diferentes diseños de las piezas permiten crear un efecto infinito colocando sucesivamente las piezas en su posición original.

Suggested placement
Sugerencia de colocación



*2 different pieces/designs come mixed in boxes
*2 piezas diferentes se sirven aleatoriamente en las cajas



WALL · Botanical Warm Natural 1200x2800 Rect.
FLOOR · Irati Oak Matt 25x150 Rect.

ARK
LANI
QUALITY DOESN'T FEAR TIME

SEVEN PEARL

ARK
LAMI

▼
6 mm
▲

NATURAL
1200x2800 mm/ 47,2"x110"
Seven Pearl Natural 1200x2800 Rect.
5 DESIGNS/5 DISEÑOS



FLOOR · Seven Pearl Natural 1200x2800 Rect.

GARLAND PEARL

ARK
LAMI

▼
6 mm
▲

NATURAL
1200x2800 mm/ 47,2"x110"
Garland Pearl Natural 1200x2800 Rect.
5 DESIGNS/5 DISEÑOS



WALL · Garland Pearl Natural 1200x2800 Rect. / Seven Pearl Natural 1200x2800 Rect.
FLOOR · Seven Pearl Natural 1200x2800 Rect.

SEVEN SILVER

ARK
LAMI

▼
6 mm
▲

NATURAL
1200x2800 mm/ 47,2"x110"
Seven Silver Natural 1200x2800 Rect.
5 DESIGNS/5 DISEÑOS

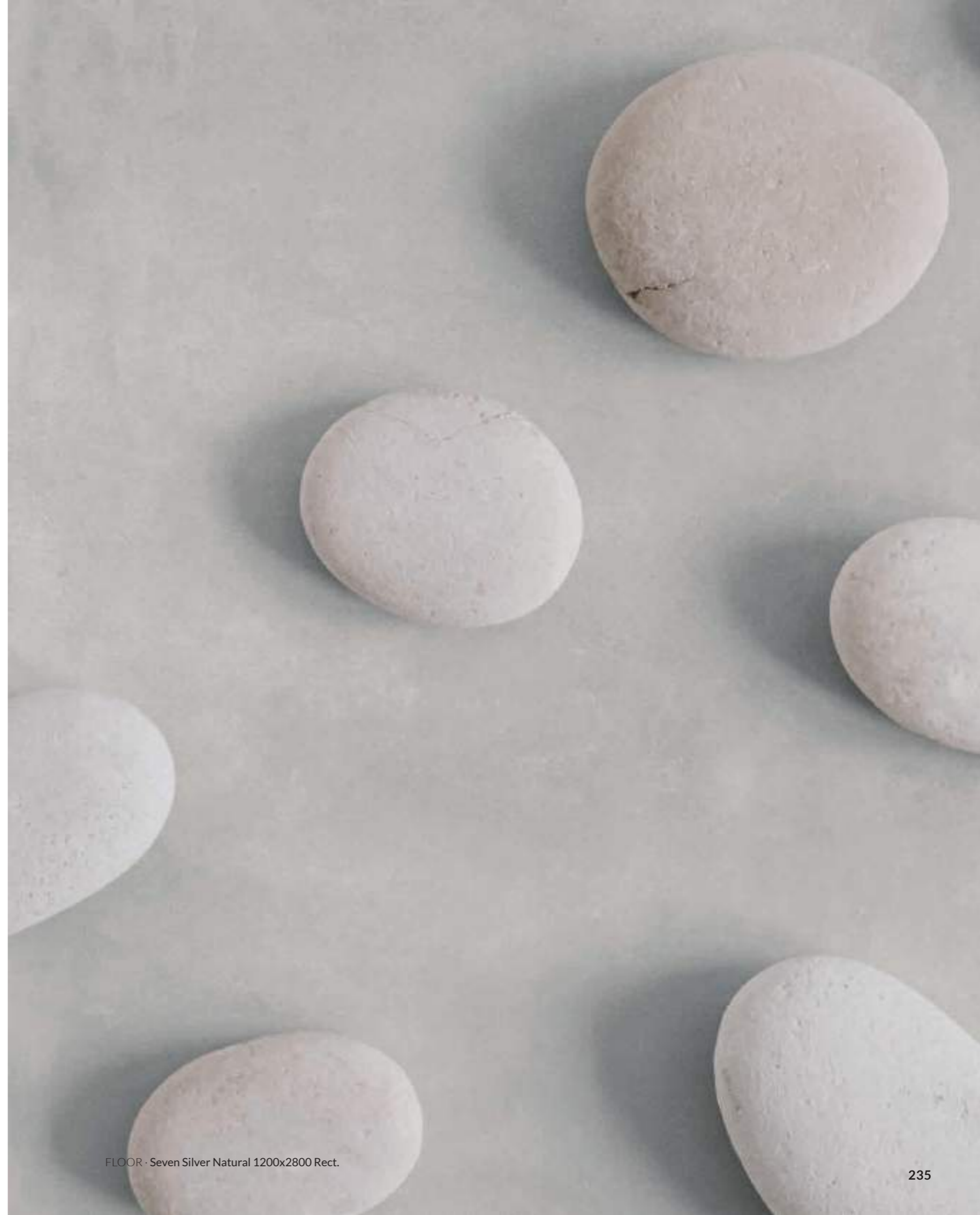

FLOOR - Seven Silver Natural 1200x2800 Rect.

GARLAND SILVER

ARK
LAMI

▼
6 mm
▲

NATURAL
1200x2800 mm/ 47,2"x110"
Seven Silver Natural 1200x2800 Rect.
5 DESIGNS/5 DISEÑOS



WALL · Garland Silver Natural 1200x2800 Rect.

SEVEN GREY

ARK
LAMI

▼
6 mm
▲

NATURAL
1200x2800 mm/ 47,2"x110"
Seven Grey Natural 1200x2800 Rect.
5 DESIGNS / 5 DISEÑOS



WALL · Seven Grey Natural 1200x2800 Rect.
FLOOR · Seven Grey Natural 1200x2800 Rect.

GARLAND GREY

ARK
LAMI

▼
6 mm
▲

NATURAL
1200x2800 mm/ 47,2"x110"
Seven Grey Natural 1200x2800 Rect.
5 DESIGNS/5 DISEÑOS



WALL - Garland Grey Natural 1200x2800 Rect.

SEVEN DARK GREY

ARK
LAMI

▼
6 mm
▲

NATURAL
1200x2800 mm/ 47,2"x110"
Seven Dark Grey Natural 1200x2800 Rect.
5 DESIGNS/5 DISEÑOS



WALL · Seven Dark Grey Natural 1200x2800 Rect.
FLOOR · Seven Dark Grey Natural 1200x2800 Rect. / Hexa Seven Cold Matt 23,2x26,7 / Irati Oak Matt 25x150 Rect.

GARLAND DARK GREY

ARK
LAMI

▼
6 mm
▲

NATURAL

1200x2800 mm/ 47,2"x110"

Garland Dark Grey Natural 1200x2800 Rect.

5 DESIGNS/5 DISEÑOS



WALL · Garland Dark Grey Natural 1200x2800 Rect.

BOTANICAL COLD

ARK
LAMI

▼
6 mm
▲

NATURAL
1200x2800 mm/ 47,2"x110"
Botanical Cold Natural 1200x2800 Rect.
2 DESIGNS / 2 DISEÑOS



WALL · Botanical Cold Natural 1200x2800 Rect. / Seven Silver Natural 1200x2800 Rect.
FLOOR · Seven Silver Natural 1200x2800 Rect.

BOTANICAL COLD

ENDLESS

The different designs of the pieces allow creating an infinite effect by successively placing the pieces in their original position.

Los diferentes diseños de las piezas permiten crear un efecto infinito colocando sucesivamente las piezas en su posición original.

Suggested placement
Sugerencia de colocación



*2 different pieces/designs come mixed in boxes
*2 piezas diferentes se sirven aleatoriamente en las cajas



WALL · Botanical Cold Natural 1200x2800 Rect. / Seven Silver Natural 1200x2800 Rect.
FLOOR · Seven Silver Natural 1200x2800 Rect.

ARK
LANI
QUALITY DOESN'T FEAR TIME

SIDNEY MOKA

ARK
LANT

▼
6 mm
▲

NATURAL
1000x3000 mm/ 39,4"x118"
Sidney Moka Natural 1000x3000 Rect.
6 DESIGNS / 6 DISEÑOS



WALL&FLOOR - Sidney Moka Natural 1000x3000 Rect.

ARK
LAMI
QUALITY DOESN'T FEAR TIME

STYLE
COLLECTION

WALL · Aqua Polished Decor 1200x3000 Rect. / Negro Marquina Silk 1000x3000 Rect.
FLOOR · Village Silk 1000x3000 Rect.



AQUA

ARK
LAM

▼ POLISHED
6 mm
▲ 1200x3000 mm/ 47,2"x118"
Aqua Polished Decor 1200x3000 Rect.
6 DESIGNS / 6 DISEÑOS



WALL · Aqua Polished Decor 1200x3000 Rect.
FLOOR · Avenue Graphite Silk 1200x3000 Rect.

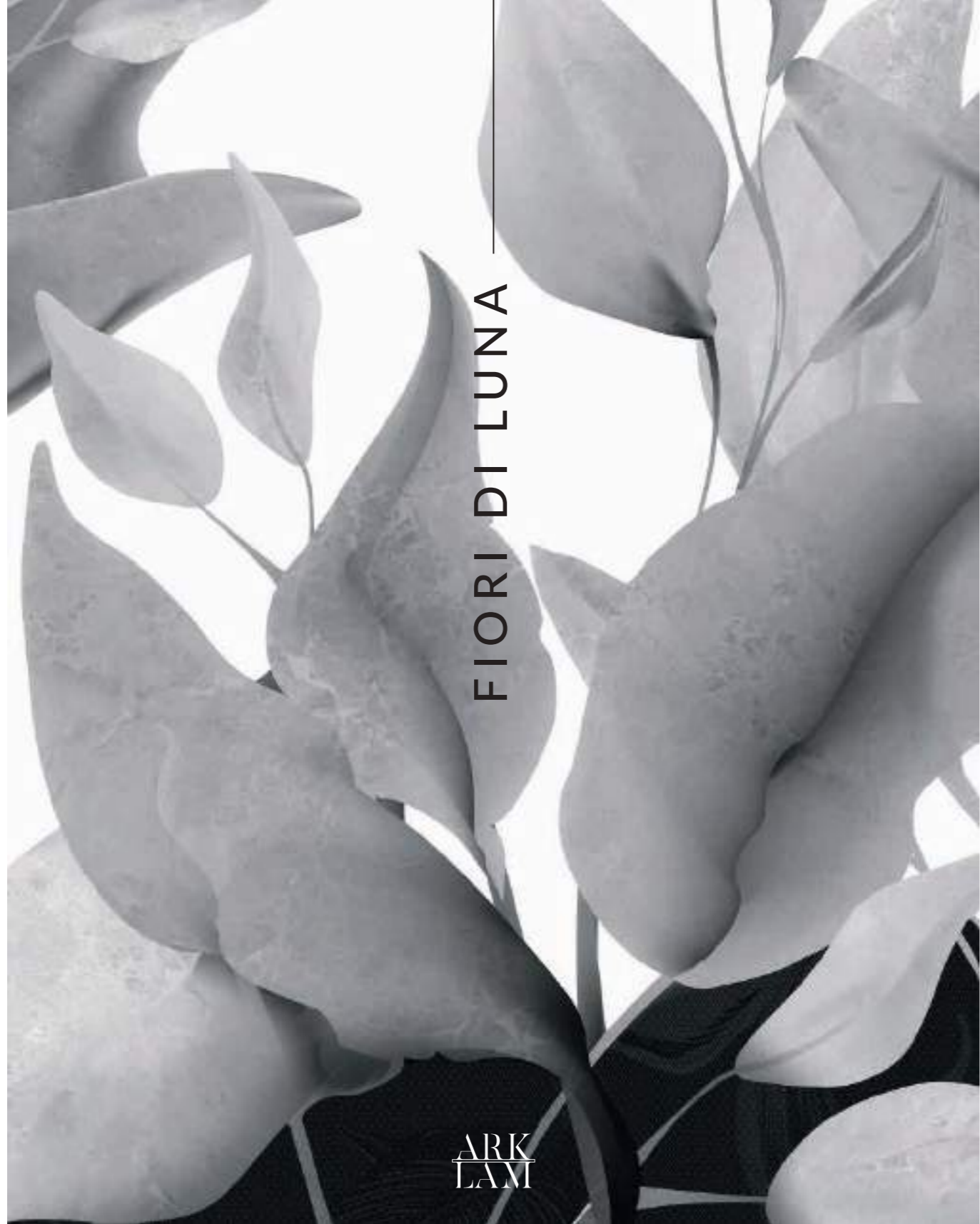

FIORI DI LUNA

ARK
LAXI

▼
6 mm
▲

HOND
1200x3000 mm/ 47,2"x118"
Fiori di Luna Hond 1200x3000 Rect.

2 DESIGNS / 2 DISEÑOS



WALL · Fiori di Luna Hond 1200x3000 Rect.

FIORI DI LUNA

ENDLESS

The different designs of the pieces allow creating an infinite effect by successively placing the pieces in their original position.

Los diferentes diseños de las piezas permiten crear un efecto infinito colocando sucesivamente las piezas en su posición original.

Suggested placement
Sugerencia de colocación



*2 different pieces/designs come mixed in boxes
*2 piezas diferentes se sirven aleatoriamente en las cajas



WALL - Fiori di Luna Hond 1200x3000 Rect.
FLOOR - Pandora Silk 1200x3000 Rect.

ARK
LANI
QUALITY DOESN'T FEAR TIME

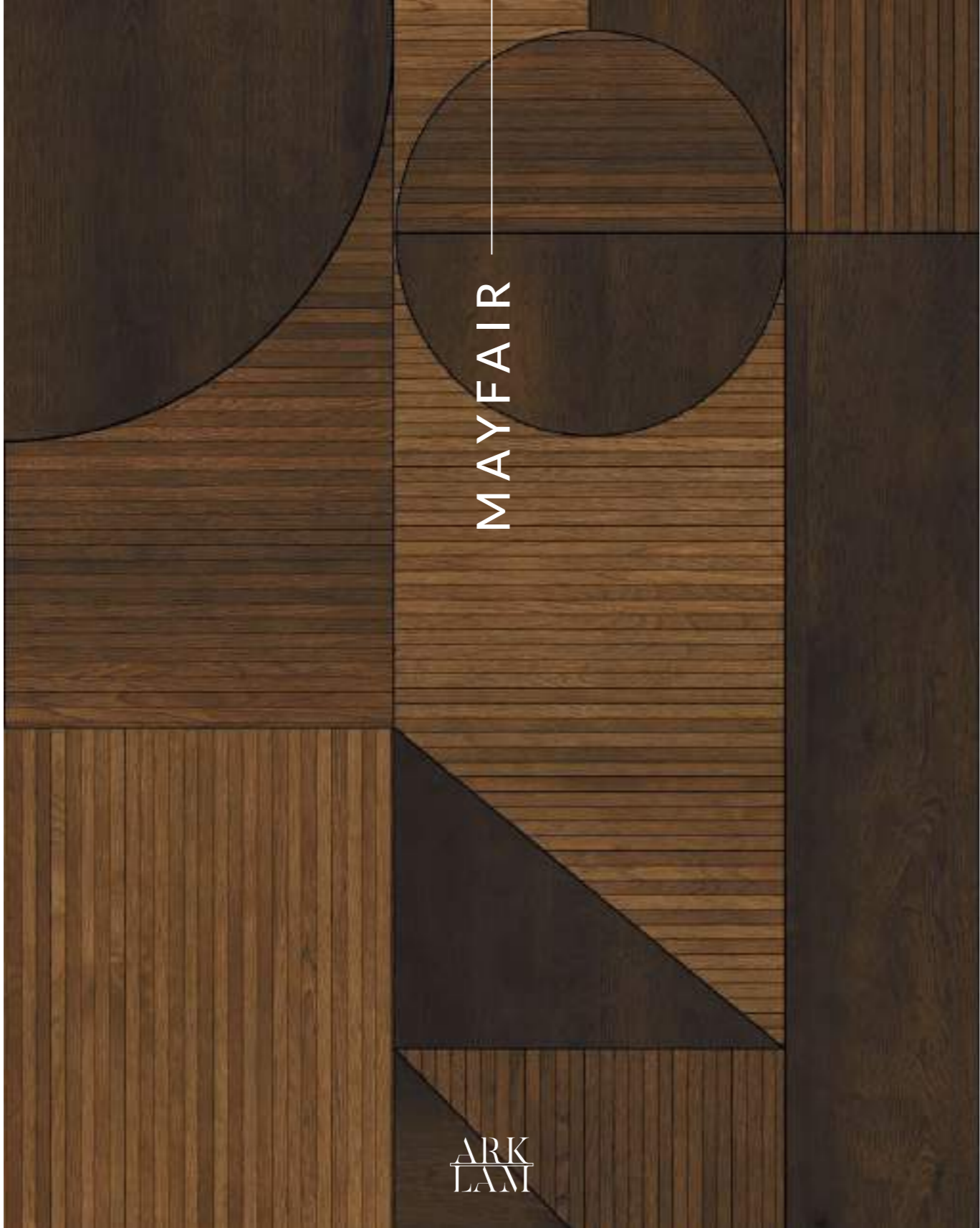

▼
6 mm
▲

NATURAL
1200x3000 mm/ 47,2"x118"
Myfair Oak Natural 1200x3000 Rect.
2 DESIGNS / 2 DISEÑOS



WALL · Mayfair Oak Natural 1200x3000 Rect.

MYFAIR

1200 X 3000

Suggested placement
Sugerencia de colocación



*2 different pieces/designs come mixed in boxes
*2 piezas diferentes se sirven aleatoriamente en las cajas



WALL · Mayfair Oak Natural 1200x3000 Rect.
FLOOR · Montreal Light Matt 19,2x119,2 Rect.

ARK
LAMI
QUALITY DOESN'T FEAR TIME

**ARK
LAM**
QUALITY DOESN'T FEAR TIME

CONCRETE COLLECTION

WALL · Concrete Silk 1000x3000 Rect.
FLOOR · Estuario Hond 1200x3000 Rect.
FURNITURE · Estuario Hond 1600x3200

CONCRETE

ARK
LAMI

3 mm & 3mm Plus

SILK

1000x3000 mm/ 39,4"x118"
Concrete Silk 1000x3000 Rect.

1 SINGLE DESIGN / 1 ÚNICO DISEÑO

*PLUS means that the material is served entangled.
*PLUS significa que el material se sirve enmallado



WALL · Concrete Silk 1000x3000 Rect.

ARK
LAMI
QUALITY DOESN'T FEAR TIME

BASIC LINE COLLECTION

WALL · Pure Black Silk 1000x3000 Rect. / Pure White Silk 1000x3000 Rect.
FLOOR · Pure Black Silk 1000x3000 Rect.

PURE BLACK

ARK
LANT

▼
3 mm
▲
SILK
1000x3000 mm/ 39,4"x118"
Pure Black Silk 1000x3000 Rect.

▼
6 mm
▲
POLISHED / SILK
1200x3000 mm/ 47,2"x118"
Pure Black Polished 1200x3000 Rect.
Pure Black Silk 1200x3000 Rect.

▼
12&20 mm
▲
HOND
1600x3200 mm/ 63"x126"
Pure Black Hond 1600x3200



WALL&FLOOR - Pure Black Polished 1200x3000 Rect.
FURNITURE - Brazil Super White Hond 1600x3200

GLACIAR

ARK
LAMI

- ▼
6 mm
▲
- POLISHED / SILK
 - 1000x3000 mm/ 39,4"x118"
Glaciar Polished 1000x3000 Rect.
 - 1500x2600 mm/ 59"x103"
Glaciar Silk 1500x2600 Rect.



WALL · Glaciar Silk 1500x2600 Rect.
FLOOR · Copenhagen White Silk 1500x2600 Rect.



PURE GREY

ARK
LANT

▼
6 mm
▲
SILK
1000x3000 mm/39,4"x118"
Pure Grey Silk 1000x3000 Rect.

▼
12&20 mm
▲
HOND
1600x3200 mm/ 63"x126"
Pure Grey Hond 1600x3200



FLOOR · Pure Grey Silk 1000x3000 Rect.

PURE IVORY

ARK
LAMI

3 mm & 3mm Plus

SILK

1000x3000 mm/ 39,4"x118"
Pure Ivory Silk 1000x3000 Rect.

*PLUS means that the material is served entangled.
*PLUS significa que el material se sirve enmallado



FURNITURE - Pure Ivory Silk 1000x3000 Rect.

PURE WHITE

ARK
LANT



SILK
1000x3000 mm/ 39,4"x118"
Pure White Silk 1000x3000 Rect.



SILK
1200x3000 mm/ 47,2"x118"
Pure White Silk 1200x3000 Rect.













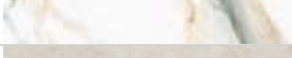
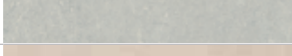

FURNITURE - Pure White Silk 1200x3000 Rect.





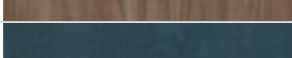
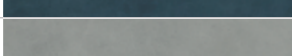
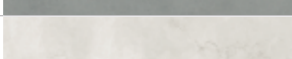
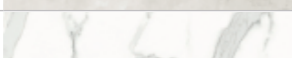

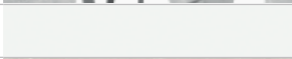
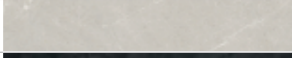
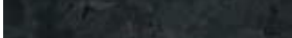

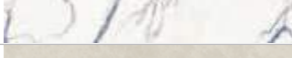

GROUTS

REJUNTES

In order to achieve the best result in the installation of Arklam, we recommend the use of specific grouts for large format pieces. For this reason, a specially selected grout colour chart has been created for each Arklam model, in collaboration with two major brands: Kerakoll and Mapei.

Para conseguir el mejor resultado en la instalación de Arklam, recomendamos el uso de rejunte específicos para piezas de gran formato. Por esta razón se ha creado una carta de colores de rejunte especialmente seleccionada para cada modelo Arklam, en colaboración con dos grandes marcas: Kerakoll y Mapei.



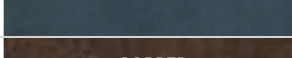
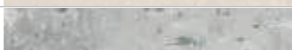





COLLECTIONS		RECOMMENDED GROUT / REJUNTE RECOMENDADO	
		Kerakoll	Mapei
AQUA		Fugabella Eco 01 Blanco	Ultracolor Plus 100
ATLANTIS		Fugabella Eco 01 Blanco	Ultracolor Plus 100
ATLANTIS GOLD		Fugabella Eco 01 Blanco	Ultracolor Plus 100
ATRIUM	BEIGE	Fugabella Eco 03 Gris Perla	Ultracolor Plus 133
	PEARL	Fugabella Eco 04 Gris Hierro	Ultracolor Plus 112
	GREY	Fugabella Eco 04 Gris Hierro	Ultracolor Plus 112
	ANTHRACITE	Fugabella Eco 06 Negro	Ultracolor Plus 120
AVENUE	WHITE	Fugabella Eco 02 Gris Luz	Ultracolor Plus 103
	ASH	Fugabella Eco 04 Gris Hierro	Ultracolor Plus 112
	TAUPE	Fugabella Eco 05 Antracita	Ultracolor Plus 114
	GRAPHITE	Fugabella Eco 06 Negro	Ultracolor Plus 120
BATEIG BLUE		Fugabella Eco 03 Gris Perla	Ultracolor Plus 133
BATEIG VERONA		Fugabella Eco 03 Gris Perla	Ultracolor Plus 133
BRAZIL SUPER WHITE		Fugabella Eco 04 Gris Hierro	Ultracolor Plus 112
CALACATTA GOLD		Fugabella Eco 01 Blanco	Ultracolor Plus 100
CALACATTA GREEN		Fugabella Eco 01 Blanco	Ultracolor Plus 100
CALACATTA PAONAZZO		Fugabella Eco 01 Blanco	Ultracolor Plus 100
CANADA		Fugabella Eco 04 Gris Hierro	Ultracolor Plus 112
CHROMATICA BLUE		Fugabella Eco 04 Gris Hierro	Ultracolor Plus 112
CONCRETE		Fugabella Eco 04 Gris Hierro	Ultracolor Plus 112
COPENHAGUEN WHITE		Fugabella Eco 03 Gris Perla	-
ESTATUARIO		Fugabella Eco 01 Blanco	Ultracolor Plus 100
FIORI DI LUNA		Fugabella Eco 01 Blanco	Ultracolor Plus 100
GLACIAR		Fugabella Eco 01 Blanco	Ultracolor Plus 100
GRIS LEVANTE		Fugabella Eco 03 Gris Perla	Ultracolor Plus 133
JURASSIC		Fugalite Bio 06 Negro	-

COLLECTIONS		RECOMMENDED GROUT / REJUNTE RECOMENDADO	
		Kerakoll	Mapei
LONDRA	BLACK	Fugalite Bio 06 Negro	Ultracolor Plus 120
	GREY	Fugabella Eco 04 Gris Hierro	Ultracolor Plus 149
LILAC		Fugabella Eco 01 Blanco	Ultracolor Plus 100
MANHATTAN	WHITE	Fugalite Bio 07 Jazmín	Ultracolor Plus 130
	BEIGE	Fugabella Eco 03 Gris Perla	Ultracolor Plus 133
	GREY	Fugabella Eco 05 Antracita	Ultracolor Plus 113
MAYFAIR		Fugabella Eco 06 Negro	Ultracolor Plus 144
MELBOURNE / MELBOURNE DECOR		Fugabella Eco 01 Blanco	Ultracolor Plus 100
MYSTIC GREY		Fugabella Eco 04 Gris Hierro	Ultracolor Plus 119
NEGRO MARQUINA		Fugalite Bio 06 Negro	-
OMNIA WHITE		Fugabella Eco 02 Gris Luz	Ultracolor Plus 103
ONICE BLACK		Fugalite Bio 06 Negro	-
ONIX	JADE	Fugabella Eco 03 Gris Perla	Ultracolor Plus 133
	BEIGE	Fugabella Eco 03 Gris Hierro	Ultracolor Plus 112
	PEARL	Fugabella Eco 04 Gris Hierro	Ultracolor Plus 112
ONIX TURQUOISE		Fugabella Eco 01 Blanco	Ultracolor Plus 100
PALISANDRO		Fugabella Eco 04 Gris Hierro	Ultracolor Plus 119
PANDORA		Fugabella Eco 01 Blanco	Ultracolor Plus 100
PATAGONIA		Fugabella Eco 03 Gris Perla	Ultracolor Plus 133
PHOENIX BLUE		Fugabella Eco 04 Gris Hierro	Ultracolor Plus 112
PIER17	COPPER	Fugabella Eco 06 Negro	Ultracolor Plus 144
	ZINC	Fugalite Bio 06 Negro	Ultracolor Plus 119
PIETRA CORAL	NATURAL	Fugabella Eco 01 Blanco	Ultracolor Plus 100
	PEARL	Fugabella Eco 03 Gris Perla	Ultracolor Plus 133
	SAND	Fugabella Eco 03 Gris Perla	Ultracolor Plus 133
POMPEIA		Fugabella Eco 04 Gris Hierro	Ultracolor Plus 112

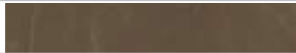
GROUTS REJUNTES

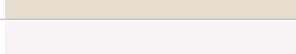
In order to achieve the best result in the installation of Arklam, we recommend the use of specific grouts for large format pieces. For this reason, a specially selected grout colour chart has been created for each Arklam model, in collaboration with two major brands: Kerakoll and Mapei.

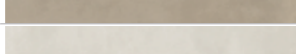
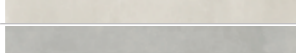
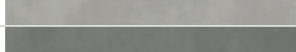
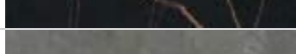
Para conseguir el mejor resultado en la instalación de Arklam, recomendamos el uso de rejunte específicos para piezas de gran formato. Por esta razón se ha creado una carta de colores de rejunte especialmente seleccionada para cada modelo Arklam, en colaboración con dos grandes marcas: Kerakoll y Mapei.

COLLECTIONS		RECOMMENDED GROUT / REJUNTE RECOMENDADO	
		Kerakoll	Mapei
PORTLAND		Fugabella Eco 05 Antracita	Ultracolor Plus 113
PORTOBELLO		Fugabella Eco 02 Gris Luz	Ultracolor Plus 103
PULPIS NATURAL		Fugalite Bio 12 Nogal	Ultracolor Plus 149
PURE BLACK		Fugabella Eco 06 Negro Fugalite Bio 06 Negro	-
PURE GREY		Fugabella Eco 04 Gris Hierro	Ultracolor Plus 119
PURE IVORY		Fugabella Eco 01 Blanco	Ultracolor Plus 100
PURE WHITE		Fugabella Eco 01 Blanco	Ultracolor Plus 100
ROSA PERSIA		Fugabella Eco 03 Gris Perla	Ultracolor Plus 133
SAHARA NOIR		Fugalite Bio 06 Negro	-
SEVEN BEIGE / GARLAND BEIGE		Fugabella Eco 03 Gris Perla	Ultracolor Plus 133
SEVEN SAND / GARLAND SAND		Fugabella Eco 03 Gris Perla	Ultracolor Plus 133
SEVEN HAZELNUT / GARLAND HAZELNUT		Fugabella Eco 03 Gris Perla	Ultracolor Plus 133
SEVEN PEARL / GARLAND PEARL		Fugabella Eco 02 Gris Luz	Ultracolor Plus 103
SEVEN SILVER / GARLAND SILVER		Fugabella Eco 04 Gris Hierro	Ultracolor Plus 112
SEVEN GREY / GARLAND GREY		Fugabella Eco 05 Antracita	Ultracolor Plus 133
SEVEN DARK GREY / GARLAND DARK GREY		Fugabella Eco 05 Antracita	Ultracolor Plus 133
SAINT LAURENT		Fugalite Bio 06 Negro	-
SIDNEY MOKA		Fugalite Bio 04 Gris Hierro	Ultracolor Plus 112
SYRAC		Fugabella Eco 01 Blanco	Ultracolor Plus 100
TRAVERTINE NAVONA		Fugabella Eco 03 Gris Perla	Ultracolor Plus 133
TRAVERTINO		Fugabella Eco 07 Jazmín	Ultracolor Plus 137

PACKING EMBALAJE

FORMAT FORMATO	BOXES / CAJAS			PALET / PALLET			
	PIECES PIEZAS	M2	NET WEIGHT PESO NETO (Kg)	PIECES PIEZAS	M2	NET WEIGHT PESO NETO (Kg)	GROSS WEIGHT PESO BRUTO (Kg)
1200x3000 mm / 47,2"x118"	1	3,60	52,13	20	72	1.043	1.168
1000x3000 mm 39,4"x118"	6mm	1	3	20	60	840	990
	3mm / 3mmPLUS	1	3	32	96	835,60	900
1500x2600 mm / 59"x103"	1	3,90	56,25	16	62,40	900	1.076,50
1200X2800 mm / 47,2"x110"	1	3,36	47,80	20	67,20	955,60	1.105,60
1500x1500 mm / 59"x59"	1	2,25	32,00	24	54	768	862,06
1200 x1200 mm / 47,2"x47,2"	1	1,44	20,62	42	60,48	866,07	966,07
600x1200 mm / 23,6"x47,2"	1	0,72	10,31	84	60,48	866,07	966,07
1000x1000 mm / 39,4"x39,4"	2	2	29,10	48	48	698,40	750,20

Jurassic Gold Polished Decor, Onix Turquoise Polished Decor

Series sold by piece. This pieces are a third-fire decoration, they can be served of unitary form.

The only additional cost that has to be applied is the wooden drawer.

Serie vendida por pieza. Estas piezas son una decoración de tercer fuego, se pueden servir de forma unitaria.

El único coste añadido que se tiene que aplicar es el cajón de madera.

FORMAT FORMATO	PALLET DIMENSIONS / DIMENSIONES PALET (mm)		
	HEIGHT ALTO	LENGTH LARGO	WIDTH ANCHO
1200x3000 mm / 47,2"x118"	340	3.400	1.360
1000x3000 mm/ 39,4"x118"	6mm	410	3.180
	3mm / 3mmPLUS	360	3.860
1500x2600 mm/ 59"x103"	360	2.860	1.620
1200X2800 mm / 47,2"x110"	410	3.180	1.320
1500x1500 mm / 59"x59"	365	1.620	1.620
1200 x1200 mm / 47,2"x47,2"	360	2.750	1.330
600x1200 mm / 23,6"x47,2"	360	2.750	1.330
1000x1000 mm / 39,4"x 39,4"	630	1.120	1.120

TECHNICAL CHARACTERISTICS

CARACTERÍSTICAS TÉCNICAS

TECHNICAL CHARACTERISTICS/ CARACTERÍSTICAS TÉCNICAS	REFERENCE STANDARD/ NORMA DE REFERENCIA	VALUE REQUIRED/ VALOR REQUERIDO		MEAN VALUE/ VALOR MEDIO OBTENIDO	
		6 mm	3 mm	6 mm	3 mm

DIMENSIONAL CHARACTERISTICS / CARACTERÍSTICAS DIMENSIONALES

Permissible deviation from work size.
Desviación admisible respecto de la dimensión de fabricación.

Length and width/ Longitud y anchura	EN-ISO 10545-2	± 0,6 % / ± 2,0 mm	± 0,6 % / ± 2,0 mm	± 0,6 % / ± 2,0 mm	± 0,6 % / ± 2,0 mm
Thickness/ Grosor		± 5 % / ± 0,5 mm	± 5 % / ± 0,5 mm	± 5 % / ± 0,5 mm	± 0,5 mm
Warpages of edges/ Rectitud de los lados		± 0,5 % / ± 2 mm	± 0,5 % / ± 2 mm	± 0,5 % / ± 2 mm	± 0,5 % / ± 2 mm
Wedging/ Ortogonalidad		± 0,6 % / ± 2,0 mm	± 0,6 % / ± 2,0 mm	± 0,6 % / ± 2,0 mm	± 0,6 % / ± 2,0 mm
Flatness/ Planaridad		± 0,5 % / ± 2,0 mm	± 0,5 % / ± 2,0 mm	± 0,5 % / ± 2,0 mm	± 0,5 % / ± 2,0 mm

CHEMICAL CHARACTERISTICS / CARACTERÍSTICAS QUÍMICAS

Resistance to household cleaning products and swimming pool additives/ Resistencia a productos domésticos de limpieza y aditivos de piscina.	EN-ISO 10545-13	GB Min./ Mín. GB	GB Min./ Mín. GB	Resist (GA)/ Resiste (GA)	Resist (GA)/ Resiste (GA)
Resistance to acids and bases in low concentration/ Resistencia a ácidos y bases en baja concentración.	EN-ISO 10545-13	As indicated by manufacturer/ Indicada por el fabricante	As indicated by manufacturer/ Indicada por el fabricante	Resist (GLA)/ Resiste (GLA)	Resist (GLA)/ Resiste (GLA)
Resistance to staining/ Resistencia a las manchas	EN-ISO 10545-14	Class 3 min./ Mín. Clase 3	Class 3 min./ Mín. Clase 3	Class 5/ Clase 5	Class 5/ Clase 5

TECHNICAL CHARACTERISTICS/ CARACTERÍSTICAS TÉCNICAS	REFERENCE STANDARD/ NORMA DE REFERENCIA	VALUE REQUIRED / VALOR REQUERIDO		MEAN VALUE/ VALOR MEDIO OBTENIDO	
		6 mm	3 mm	6 mm	3 mm

PHYSICAL CHARACTERISTICS / CARACTERÍSTICAS FÍSICAS

Water absorption/ Absorción al agua	EN-ISO 10545-3	≤ 0,5 %	≤ 0,5 %	≤ 0,5 %	≤ 0,5 %
Breaking strength/ Fuerza de rotura	EN-ISO 10545-4	≥ 700 N	As indicated by manufacturer/ Indicada por el fabricante	Standard overtakes/ Supera la norma	360
Bending strength/ Resistencia a la flexión	EN-ISO 10545-4	≥ 35 N / mm ²	As indicated by manufacturer/ Indicada por el fabricante	Standard overtakes/ Supera la norma	≥ 35 N / mm ²
Resistance to deep abrasion / Resistencia a la abrasión profunda	EN-ISO 10545-6	≤ 175 mm ³	-	Standard overtakes/ Supera la norma	-
Resistance to abrasion utility - PEI/ Resistencia a la abrasión PEI	EN-ISO 10545-7	Indicate the result/ Indicar resultado	Indicate the result/ Indicar resultado	1 - 5	2
Lineal thermal expansion/ Dilatación Térmica lineal	EN-ISO 10545-8	Indicate the result/ Indicar resultado	Indicate the result/ Indicar resultado	≤ 9 X 10 ⁻⁶ K ⁻¹	≤ 9 X 10 ⁻⁶ K ⁻¹
Thermal shock resistance/ Resistencia al choque térmico	EN-ISO 10545-9	Pass test/ Superar prueba	Pass test/ Superar prueba	Resist/ Resiste	Resist/ Resiste
Mohs surface hardness/ Dureza Mohs	EN 101	Indicate the result/ Indicar resultado	-	5 - 6	-
Frost resistance/ Resistencia a la helada	EN-ISO 10545-12	Pass test/ Superar prueba	Pass test/ Superar prueba	Resist/ Resiste	Resist/ Resiste
Fire resistance/ Resistencia al fuego	Decision 96/603/CE Modified Decisión 96/603/CE Modificada	A1	A1	A1 _n	A1 _n



ARK
Skin
LAM
QUALITY DOESN'T FEAR TIME

SLIM THICKNESS / 6mm

TECHNICAL SUPPORT

Arklam's technical team offers architects and engineers the support they need for the development of their construction projects. Through personalised advice, from planning to execution, Arklam provides these professionals with all its know-how in the field of ventilated facades, especially with regard to technical specifications and quality requirements.

SOPORTE TÉCNICO

El equipo técnico de Arklam ofrece a arquitectos e ingenieros el soporte que precisan para el desarrollo de sus proyectos de construcción. A través de un asesoramiento personalizado, que abarca desde la planificación hasta la ejecución, Arklam pone al servicio de estos profesionales todo su know-how en materia de fachadas ventiladas, especialmente en lo relativo a especificaciones técnicas y requisitos de calidad.

A LIGHTWEIGHT SKIN TO WRAP WITH STRENGTH AND DURABILITY

Ventilated facades made with Arklam are waterproof, allow air circulation and improve solar protection and thermal and acoustic insulation. They are resistant to thermal shock, low temperatures, UV rays, wear, scratching, bending and chemicals and are environmentally friendly and easy to clean.

At the same time, Arklam adds the features of the sintered mass, such as its lightness and fine thickness (3&6 mm) and its exceptional finishes, which make it an outstanding choice for dressing the skin of any type of building, both new execution and rehabilitation.

Arklam has its own installation system (Arktech) with three types that adapt to the requirements of each project, making installation easier and saving time and costs. These systems combined with the Arklam cladding provide the whole with an important added value as an innovative construction solution, especially in terms of durability and energy efficiency. In this sense, Arklam's team of specialists carries out a complete study to analyse all these variables and propose the ideal system for each case.

UNA PIEL LIGERA PARA ENVOLVER CON RESISTENCIA Y DURABILIDAD

Las fachadas ventiladas realizadas con Arklam son impermeables, permiten la circulación del aire y mejoran la protección solar y el aislamiento térmico y acústico. Son resistentes al choque térmico, a las bajas temperaturas, a los rayos UV, al desgaste, al rayado, a la flexión y a los químicos y, además, son respetuosas con el medio ambiente y fáciles de limpiar.

A todo ello, Arklam suma las prestaciones propias de la masa sinterizada, como son su ligereza y fino espesor (3 y 6 mm) y sus excepcionales acabados, que le convierten en una elección sobresaliente para vestir la piel de cualquier tipo de edificación, tanto de nueva ejecución como de rehabilitación.

Arklam dispone de un sistema propio de colocación (Arktech) con tres tipologías que se adaptan a los requerimientos de cada proyecto, facilitando la instalación y potenciando el ahorro de tiempo y de costes. Estos sistemas combinados con el revestimiento Arklam aportan al conjunto un importante valor añadido como solución constructiva innovadora, sobre todo en cuanto a durabilidad y eficiencia energética. En este sentido, el equipo de especialistas de Arklam realiza un estudio completo para analizar todas estas variables y proponer el sistema idóneo en cada caso.

INTERNATIONAL OUTREACH

PROYECCIÓN INTERNACIONAL

With Arklam, ventilated facades acquire a new dimension as an architectural element, turning them into an authentic insulating skin that ensures the greatest comfort inside the building.

Arklam enhances efficiency and sustainability in construction and, due to its unbeatable performance, its projection in the world is non-stop. Progressively, more and more buildings are 'dressed' with the sintered mass of large format that guarantees an impeccable result.

Con Arklam, las fachadas ventiladas adquieren una nueva dimensión como elemento arquitectónico, convirtiéndolas en una auténtica piel aislante que asegura el mayor confort en el interior de la edificación.

Arklam potencia la eficiencia y la sostenibilidad en la construcción y, debido a sus inmejorables prestaciones, su proyección en el mundo es imparable. Progresivamente, son cada vez más los edificios 'vestidos' con la masa sinterizada de gran formato que garantiza un resultado impecable.



WALL&FLOOR · Pier17 Zinc Natural 1200x3000 Rect. / Glaciér Silk 1000x3000 Rect.

ARK
Skin
LAM
QUALITY DOESN'T FEAR TIME



AVANT-GARDE IN DESIGN

VANGUARDIA EN DISEÑO

Arklam ventilated facade systems are a constructive solution in which the achievement of functional and aesthetic objectives are an absolute priority. In each project, these parameters compose its 'core', from the initial phase (study and conception), through its development and execution to the final assembly and installation. And throughout the process the design is also key. For this reason, Arklam has a wide catalogue of avant-garde designs that cover all trends and styles.

Los sistemas de fachada ventilada Arklam son una solución constructiva en la que la consecución de los objetivos funcionales y estéticos son una absoluta prioridad. En cada proyecto, estos parámetros componen su 'core', desde la fase inicial (estudio y concepción), pasando por su desarrollo y ejecución hasta llegar al montaje e instalación final.

Y en todo el proceso el diseño es también clave. Por eso, Arklam cuenta con un amplio catálogo de diseños de vanguardia que abarcan todas las tendencias y estilos.

ARK
Skin
LAMI
QUALITY DOESN'T FEAR TIME

WALL · Glaciar Silk 1500x2600 Rect.

ARK
LAMI
QUALITY DOESN'T FEAR TIME

VENTILATED FACADE

FASTENING SYSTEMS

SISTEMAS DE FIJACIÓN **FACHADAS VENTILADAS**

ARKTECH GL SYSTEM

ARKTECH GL SYSTEM is a self-supporting metal substructure kit, which is connected to the supporting wall and does not contribute to the stability of the construction, designed for the outer cladding of Arklam Slim 6 mm.

ARKTECH GL SYSTEM is a system for fixing lightweight panels (Arklam Slim 6 mm) on ventilated facades. For the installation of this system few elements are needed which makes it a very simple system to install and due to the great variety of light panels on the market it is easy to give the building a unique architectural design, safe and really effective.

The system is composed by support and retention brackets, vertical profiles with a "T" and "L" shaped. The panels will be fix to vertical profiles with a bonding system called Panel-Tack, formed by double-sided tape and MS polymer adhesive.

ARKTECH GL SYSTEM es un kit de subestructura metálica autoportante solidaria con el muro soporte, que no contribuye a la estabilidad de la construcción, concebido para el revestimiento exterior de Arklam Slim 6 mm.

ARKTECH GL SYSTEM es un sistema para la fijación de paneles ligeros (Arklam Slim 6 mm) en fachada ventilada. Para la instalación de este sistema se necesitan pocos elementos, lo cual hace que sea un sistema muy sencillo de instalar y, debido a la gran variedad de paneles ligeros en el mercado, es fácil conseguir darle al edificio un diseño arquitectónico singular, seguro y realmente efectivo.

El sistema se compone de ménsulas de sustentación y retención, perfiles verticales en forma de "T" y "L". Los paneles serán fijados a los perfiles verticales con un sistema de pegado llamado Sikatak panel, formado por cinta de doble cara y adhesivo.

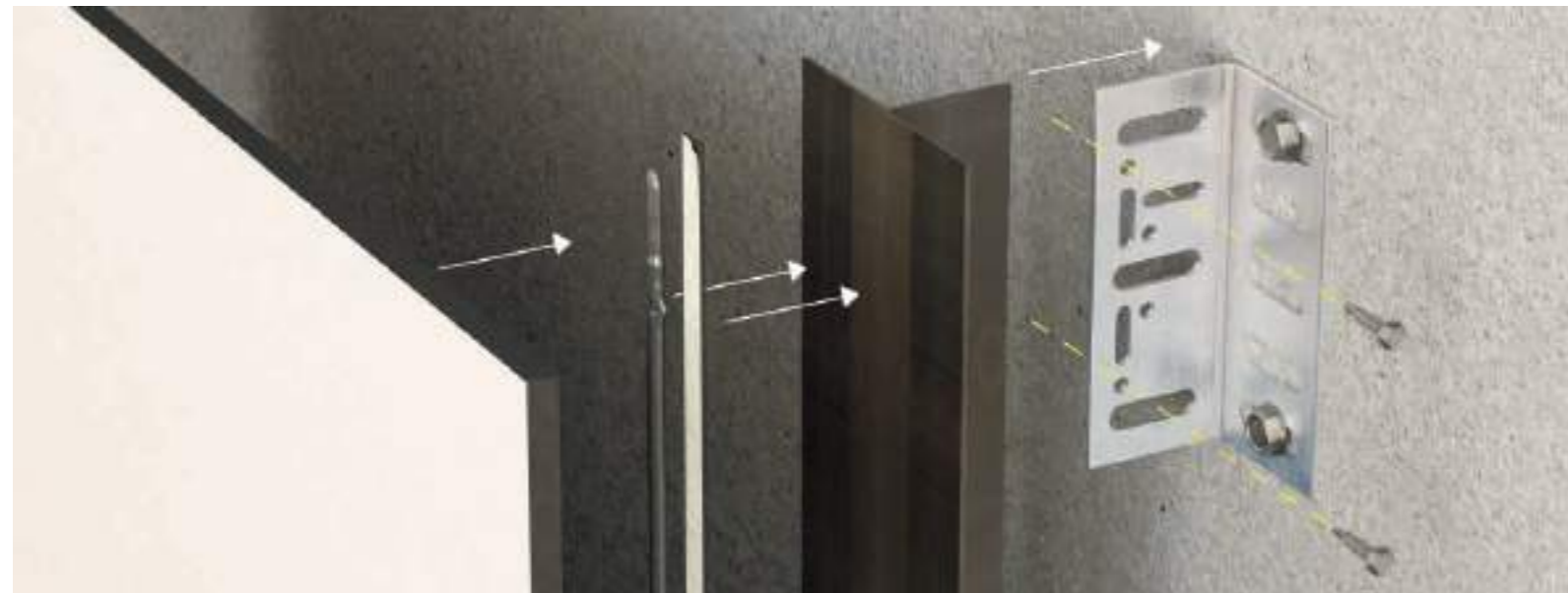

ALUMINUM BRACKETS ESCUADRAS O MÉNSULAS DE ALUMINIO

The fixation system in framework edges and walls is done by adjustable support and retention brackets respectively. They are made of extruded aluminum, which is an alloy of aluminum-magnesium-silicon of 6063 quality (Al Mg Si 0'5), with T-5 treatment.

The brackets dimensions will vary depending on project because factors like facing planimetry to recover or width of air chamber influence in geometry of spacers used.

El sistema de fijación en los cantos de forjado y muros se realiza mediante escuadras regulables de sustentación y retención respectivamente. El material de que están fabricadas es aluminio extruido de aleación aluminio-magnesio-silicio de calidad 6063 (Al Mg Si 0,5), con tratamiento T-5.

Las dimensiones de las ménsulas variarán en función del proyecto a realizar ya que factores como la planimetría del paramento a recubrir o la anchura que se defina para la cámara de aire definirán la geometría de los separadores a utilizar.



Bracket/ Escuadra
150x65x50-350x3-5 mm



Bracket/ Escuadra
50x50x30-180x3 mm



Bracket/ Escuadra
100x65x50-350x3-5 mm

SYSTEM COMPONENTS / COMPONENTES DEL SISTEMA

ALUMINUM CHARACTERISTICS/ CARACTERÍSTICAS DEL ALUMINIO	
DESIGNATION/ DESIGNACIÓN	
Symbolic/ Simbólica	EN AW -Al Mg Si
Numerical/ Numérica	6063
Treatment/ Tratamiento (Temple)	T -5
Code/ Norma	UNE-EN 755-2 ⁽¹⁾ , UNE-EN 12020-1 ⁽²⁾ y UNE-EN 12020-2 ⁽³⁾

PHYSICAL PROPERTIES/ PROPIEDADES FÍSICAS	
Specific weight/ Peso específico	2.700 Kg/m ³
Thermal dilatation coefficient/ Coeficiente dilatación térmica 20-100°C (1/K)	23,6 x 10 ⁻⁶ K ⁻¹ (20/100°C)
Elasticity module/ Módulo de elasticidad	69.500 N/mm ²
Poisson coefficient/ Coeficiente de Poisson	0,33

MECHANICAL PROPERTIES/ PROPIEDADES MECÁNICAS	
Tensile resistance (R _m)/ Resistencia a tracción (R _m)	215 N/mm ²
Shearing resistance/ Resistencia a la cizalladura	140 N/mm ²
Elastic limit/ Límite elástico (R _{p0,2%})	145 N/mm ²
Lengthening/ Alargamiento (L _{0-mm})	12%
Lengthening/ Alargamiento (L _{50mm})	14%
Brinell hardness/ Dureza Brinell	70

(1) UNE-EN 755-2:
Aluminum and aluminum alloys. Columns, tubes and extruded profiles. Part 2: mechanical characteristics
Aluminio y aleaciones de aluminio. Barras, tubos y perfiles extruidos. Parte 2: características mecánicas.

(2) UNE-EN 12020-1:
Aluminum and aluminum alloys. Special extruded profiles in alloys EN AW-6060 and EN AW-6063.
Part 1: Technical conditions for inspection and delivery.
Aluminio y aleaciones de aluminio. Perfiles extruidos especiales en aleaciones EN AW-6060 y EN AW-6063.
Parte 1: Condiciones técnicas de inspección y suministro.

(3) UNE-EN 12020-2:
Aluminum and aluminum alloys. Special extruded profiles in alloys EN AW-6060 and EN AW-6063. Part 2: Dimensional and form tolerances.
Aluminio y aleaciones de aluminio. Perfiles extruidos en aleaciones EN AW-6060 y EN AW-6063. Parte 2: Tolerancias dimensionales y de forma.



ALUMINUM PROFILES / PERFILES DE ALUMINIO

Vertical profiles used in this system have a "T" and "L" shaped, and are made of, like brackets, in extruded aluminum from aluminum-magnesium-silica allow quality 6063 (Al Mg Si 0,5), with T-5 treatment. This kind of aluminum (6000 serial) is characterized by having a good resistance to corrosion.

The geometrical and mechanical characteristics of the vertical profiles are:

Los perfiles verticales empleados en este sistema de fachada tienen sección en forma de "T" y "L", y están fabricados, al igual que las escuadras, en aluminio extruido de aleación aluminio-magnesio-silicio de calidad 6063 (Al Mg Si 0,5), con tratamiento T-5. Este tipo de aluminio (serie 6000) se caracteriza por tener una buena resistencia a la corrosión.

Las características geométricas y mecánicas de los perfiles verticales son:

VERTICAL PROFILE CHARACTERISTICS/ CARACTERÍSTICAS DEL PERFIL VERTICAL									
PROFILE PERFIL	SECTION SECCIÓN (mm ²)	PERIMETER PERÍMETRO (mm)	WEIGHT PESO (kg/ml)	X AXIS/ EJE X			Y AXIS/ EJE Y		
				x _c (mm)	I _{xc} (cm ⁴)	r _{xc} (mm)	y _c (mm)	I _{yc} (cm ⁴)	r _{yc} (mm)
T 110X50X2	303.00	386.65	0.818	55.00	5.91	13.98	41.02	19.66	25.48
L 50X50X2	183.50	256.82	0.495	37.20	4.41	15.52	37.20	4.41	15.52

The tolerances are sought in the code UNE-EN 755-9 ⁽⁴⁾.

(4) UNE-EN 755-9: Aluminum and aluminum alloys.

Column, tubes and extruded profiles.

Part 9: Profiles, dimensional and form tolerances.

Las tolerancias se establecen en la norma UNE-EN 755-9 ⁽⁴⁾.

(4) UNE-EN 755-9: Aluminio y aleaciones de aluminio.

Barras, tubos y perfiles extruidos.

Parte 9: Perfiles, tolerancias dimensionales y de forma.

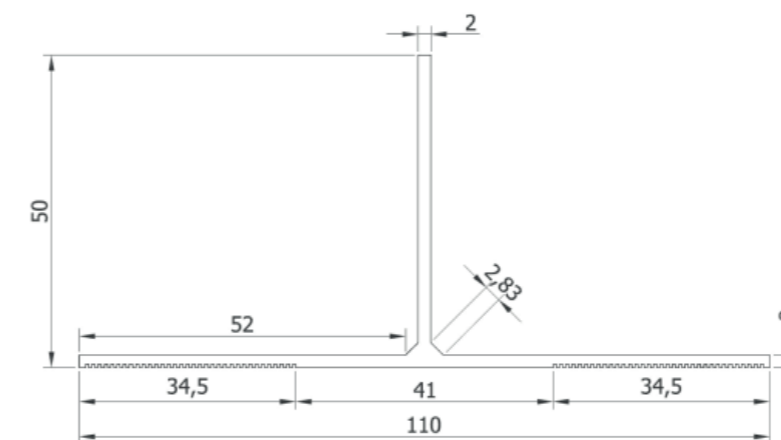

T striated profile/ Perfil T estriado
110x50x2 mm

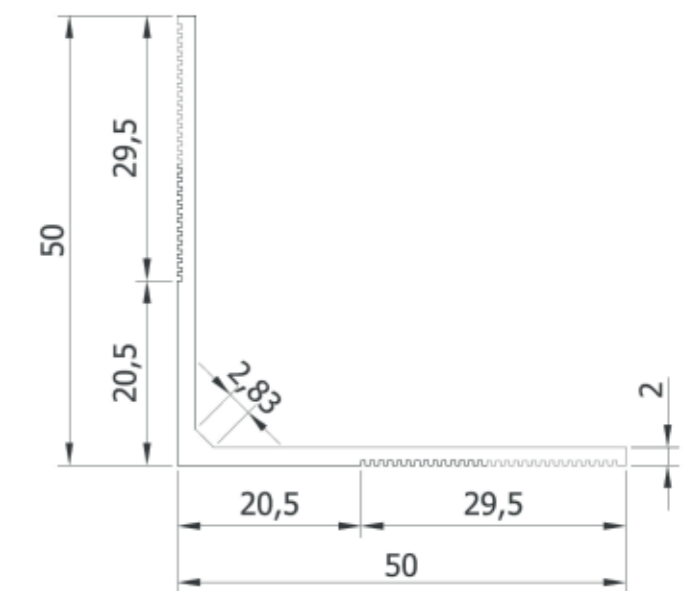

L striated profile/ Perfil L estriado
50x50x2 mm

PANEL TRACK FIXATION SYSTEM SISTEMA DE FIJACIÓN SIKATAACK PANEL

The system consists of the following elements:

Pre-treatments:

To the cladding will use Activator 205. This is an agent to prepare the surfaces, it is suitable for cleaning and degreasing of the substrates, that later will be pasted.

To aluminum profiles will use Sika Tack panel Prime. This is a pretreatment that improve the adherence between façade panels and metals.

Foamtape. Double-sided tape with silicone paper in one side. It is the first fixation of panel to the façade, while the adhesive polymerizes, and guarantees the required thickness of adhesive between the panel and profile.

SikaTack Panel. It is a one-component thixotropic polyurethane adhesive of pasty consistency that cures with exposure to atmospheric moisture to form a durable elastomer.

Once the double-sided tape has been applied, the adhesive is applied vertically and without interruption, using a manual or pneumatic gun. The end of the nozzle should be cut to ensure a uniform thickness of adhesive when compressed, we recommend applying the adhesive with triangular section to ensure a minimum dimension of 10 x 3 mm, we must cut the nozzle to approximately 10 x 8 mm. movements.

El sistema consta de los siguientes elementos:

Pretratamientos:

Para el aplacado y perfilería se utilizará Activator 205, es un agente limpiador y activador, específicamente formulado para el pretratamiento de las zonas de adhesión antes de la aplicación de adhesivos.

Para el aplacado y la perfilería de aluminio se utilizará SikaTack Panel Primer. Es un pretratamiento para mejorar la adherencia en paneles de fachada y metales.

Cinta doble cara SikaTack. La cinta doble cara con papel siliconado en una de ellas será la primera fijación del panel en la fachada, mientras el adhesivo polimeriza y garantiza el espesor necesario de adhesivo entre el panel y el perfil.

SikaTack Panel. Es un adhesivo de poliuretano monocomponente tixotrópico de consistencia pastosa que cura con la exposición a la humedad atmosférica para formar un elastómero duradero.

Una vez colocada la cinta doble cara, se aplicará el adhesivo verticalmente y sin interrupciones, utilizando pistola manual o neumática. Se deberá cortar el extremo de la boquilla para asegurar un espesor uniforme de adhesivo al ser comprimido, recomendamos aplicar el adhesivo con sección triangular para garantizar una dimensión mínima de 10 x 3 mm, debemos cortar la boquilla aproximadamente a 10 x 8 mm.



Two beads of elastic adhesive are applied along the vertical T-profile and a single bead on the L-profile, specifically in the grooved area of the profile. The adhesive ensures the correct positioning of the chosen panels, improving the system's responses to gravitational loads, pressure loads and wind suction, absorbing vibrations and thus avoiding possible clapping.

Se aplican dos cordones de adhesivo elástico a lo largo del perfil vertical en T y un único cordón en el perfil L, concretamente en la zona estriada del perfil. El adhesivo asegura el correcto posicionamiento de los paneles escogidos mejorando las respuestas del sistema a las cargas gravitatorias, cargas de presión y de succión de viento, absorbiendo las vibraciones y evitando con ello los posibles clapeteos.

ADHESIVE TECHNICAL CHARACTERISTICS/ CARACTERÍSTICAS TÉCNICAS DEL ADHESIVO

Chemical base/ Base química	1-C polyurethane/ 1-C poliuretano
Colour/ Color (CQP ⁽¹⁾ 001-1)	Ivory white/ Blanco marfil
Curing mechanism/ Mecanismo de curado	Moisture curing/ Curado por humedad
Density (not curing)/ Densidad (sin curar) (CQP 006-4)	1.1 kg/l aprox.
Thixotropy/ Tixotropía	Very good/ Muy buena
Application temperature/ Temperatura de aplicación	5-35°C (40-95 °F) - Atmosphere/ Ambiente
Skin formation/ Formación de piel ⁽²⁾ (CQP 019-1)	35 min. aprox.
Contraction/ Contracción (CQP 014-1)	6% aprox.
Hardness Shore A/ Dureza Shore A (CQP 023-1/ ISO 868)	45 aprox.
Traction resistance/ Resistencia a la tracción (CQP 036-1/ ISO 37)	2.5 N/mm ² aprox.
Fracture elongation/ Alargamiento de rotura (CQP 036-1/ ISO 37)	500% aprox.
Resistance to further tearing/ Resistencia a la continuación del desgarro (CQP 045-1/ ISO 34)	7 N/mm aprox.
Tensile shear strength/ Resistencia a la cortadura por tracción (CQP 046-1/ ISO 4587)	2.0 N/mm ² aprox.
Glass transition temperature/ Temperatura de transición vítrea (CQP 509-1/ ISO 4663)	-40°C (-40°F) aprox.
Operating temperature/ Temperatura de servicio (CQP 513-1)	-40 - 90 °C (-40 - 195 °F) 4 hours/ horas: 130 °C (265 °F) 1 hour/ hora: 150 °C (300 °F)
Useful life/ Vida útil (stockpiled/ almacenado ≤ 25°C) (CQP 016-1)	9 months/ meses

(1) CQP: Corporate Quality Procedure/ Procedimiento Corporativo de Calidad

(2) 23 °C (73 °F) / 50% r.h.

MECHANICAL FIXATION ELEMENTS / ELEMENTOS DE FIJACIÓN MECÁNICA

CLADDING JOINT:

With this system can choose the joint, both directions vertical and horizontal. Logically it depends on the cladding material dilatations and on aesthetics that he wants to modulation of the façade.

JUNTAS DEL APLACADO:

Con este sistema se podrán dejar las juntas entre placas, tanto vertical como horizontal, que queramos. Lógicamente dependerá de las dilataciones del material de aplacado elegido y de la estética que se le quiera dar a la modulación de la fachada.

MECHANICAL FIXATION ELEMENTS ELEMENTOS DE FIJACIÓN MECÁNICA

FIXATION OF VERTICAL PROFILES TO BRACKETS:

For fixing the vertical profile to the brackets used self-drilling screws of hexagonal head, DIN 7504K, made of stainless steel A2/A4. The screws normally used are as follows:

Ø6,3 mm y lenght L=25 mm. For fixed points of the support brackets.

Ø6,3 mm y lenght L=25 mm with washer of EPDM. For floating points of the support brackets.

Ø4,8mm y lenght L=19 mm with washer of EPDM. For floating points of the retention brackets.

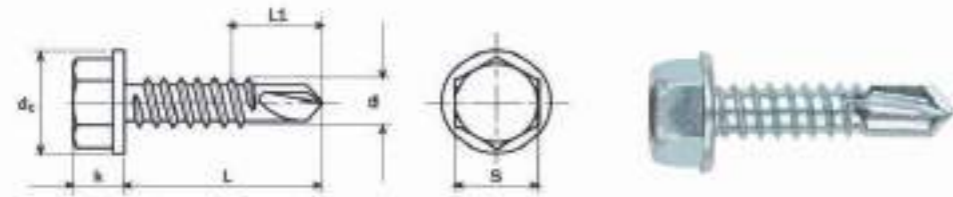

FIXATION THE BRACKETS TO THE ENCLOSURE:

The definition of the type and number of anchorages for fixing the brackets to the support is made depending on the base material and the transmitted stress to it in each case. However the anchors normally used are:

Expansive metal anchors in reinforced concrete slab (Ø8x90 mm o Ø10x90 mm), 2 ud in the support bracket.



Sometimes, it is necessary to anchor the support bracket to areas where there is no concrete slab (some outlines of windows, high-rise windowsills, cantilevers, overhangs...). Faced with this situation, a nylon plug set is used FL 10x90 mm, stainless A-2, forming by screw DIN 571 8x100 mm stainless A-2, a nylon plug FL 10x90 mm and a washer M-8 9021 stainless A-2.



Depending on the type and strenght of the enclosure, it may be more appropriate and/or necessary the use of other type of nylon plug or a chemical anchor with threaded rod (consisting of a threaded rod 8x120 stainless A2, sieve of 12x80 and polyester resin without styrene).

FIJACIÓN DE LOS PERFILES VERTICALES A LOS SEPARADORES:

Para la fijación del perfil vertical a los separadores se utiliza tornillería autotaladrante de cabeza hexagonal, DIN 7504K, fabricados en acero inoxidable A2/A4. Se utilizan por regla general los siguientes:

Ø6,3 mm y longitud L=25 mm. Para los puntos fijos de las escuadras de sustentación.

Ø6,3 mm y longitud L=25 mm con arandela de EPDM. Para los puntos flotantes de las escuadras de sustentación.

Ø4,8mm y longitud L=19 mm con arandela de EPDM. Para los puntos flotantes de las escuadras de retención

FIJACIÓN DE LOS SEPARADORES AL SOPORTE:

La definición del tipo y número de anclajes para la fijación de los separadores al soporte se realizará en función del material base y los esfuerzos transmitidos al mismo en cada caso. No obstante de forma general los anclajes que se utilizarán serán:

Anclajes metálicos expansivos en forjados de hormigón armado (Ø8x90 mm o Ø10x90 mm), 2 ud en la escuadra de sustentación.

En ciertos casos, resulta necesario anclar la ménsula de sustentación a zonas en las que no hay forjado (algunos contornos de ventana, antepechos de gran altura, voladizos, salientes...). Frente a esta situación, se recurre a un conjunto taco nylon FL 10x90 mm, inoxidable A-2, formado por un tornillo DIN 571 8x100 mm inoxidable A-2, un taco de nylon FL 10x90 mm y una arandela M-8 9021 inoxidable A-2.

Según la tipología y la resistencia del cerramiento, podría resultar más adecuado y/o necesario el uso de otro tipo de taco nylon o de un anclaje químico con varilla roscada (compuesto por una varilla roscada 8x120 inoxidable A2, tamiz de 12x80 y resina de poliéster sin estireno).

DETAILED DRAWINGS OF ARKTECH GL SYSTEM SECTIONS PLANOS DETALLE DE SECCIONES DE ARKTECH GL SYSTEM

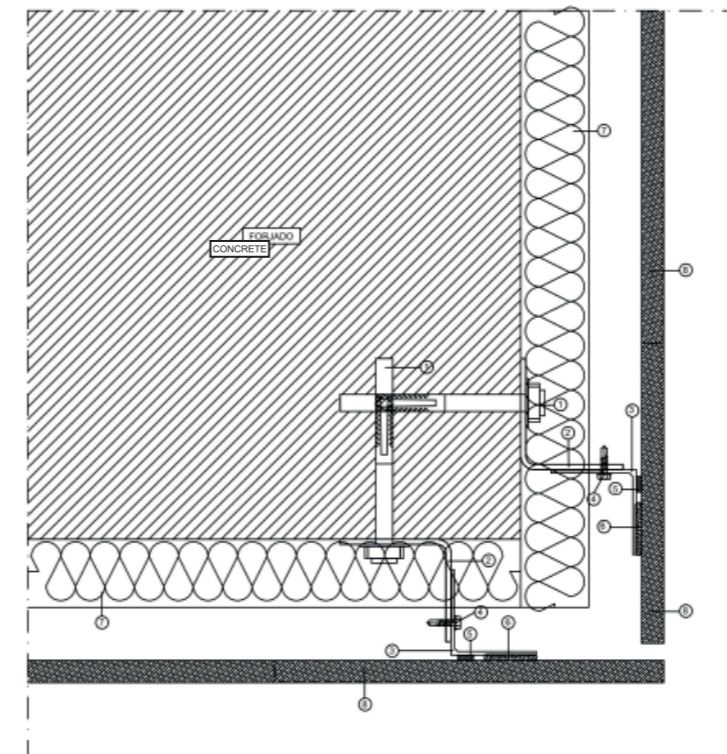

HORIZONTAL SECTION/ SECCIÓN HORIZONTAL

1. MTA anchor 10x90 stainless steel A2
2. ESC aluminium 50x50x60x3
3. Profile L 50X50X2 ribbed
4. Screw DIN 7504-K 6.3x25 stainless steel A2
5. Double-sided adhesive tape (FoamTape)
6. PanelTack-HM Glue
7. Insulation
8. External cladding

1. Anclaje MTA 10x90 inox A2
2. ESC aluminio 50x50x60x3
3. Perfil L 50X50X2 estriada
4. Tornillo DIN 7504-K 6.3x25 inox A2
5. Cinta adhesiva doble cara (FoamTape)
6. Pegamento PanelTack-HM
7. Aislante
8. Revestimiento exterior

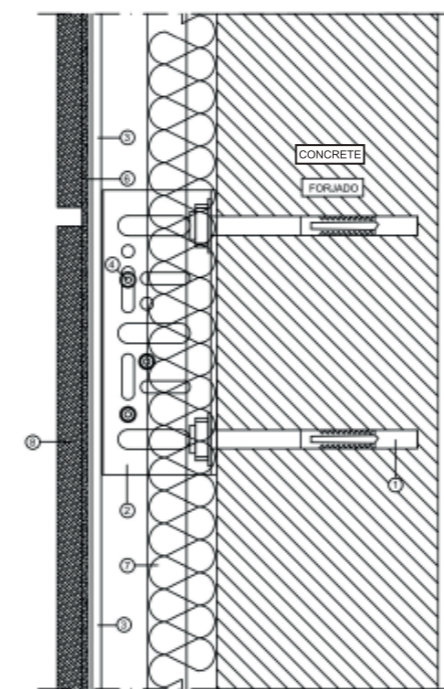

VERTICAL SECTION SECCIÓN VERTICAL

HORIZONTAL SECTION/ SECCIÓN HORIZONTAL

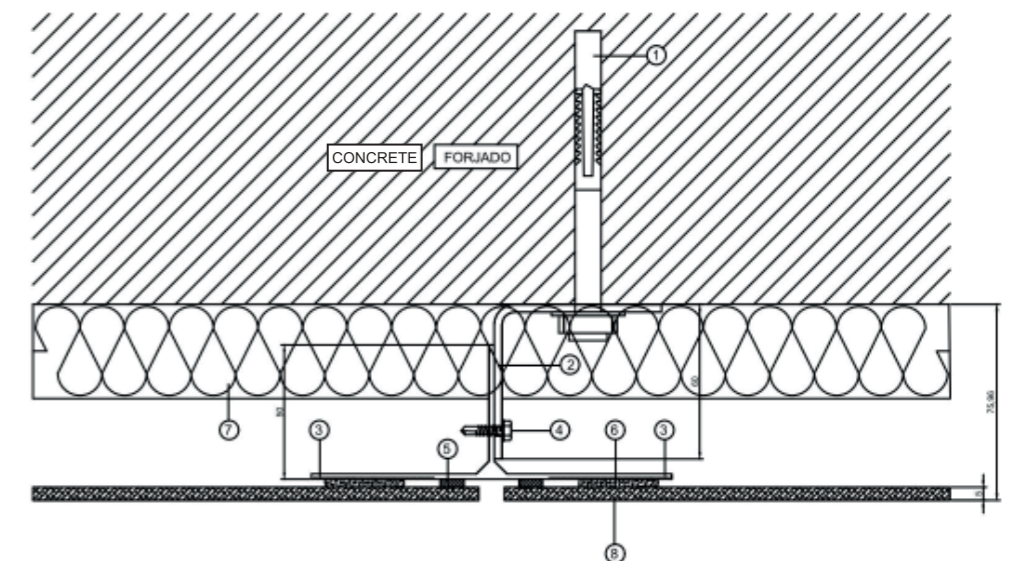

1. MTA anchor 10x90 stainless steel A2
2. ESC aluminium 150x65x60x3
3. Vertical aluminium profile "T 110x50x2".
4. Screw DIN 7504-K 6.3x25 stainless steel A2
5. Double-sided adhesive tape (FoamTape)
6. PanelTack-HM Glue
7. Insulation
8. Internal cladding

1. Anclaje MTA 10x90 inox A2
2. ESC aluminio 150x65x60x3
3. Perfil vertical aluminio "T 110x50x2"
4. Tornillo DIN 7504-K 6.3x25 inox A2
5. Cinta adhesiva doble cara (FoamTape)
6. Pegamento PanelTack-HM
7. Aislante
8. Revestimiento interior

ARKTECH VST SYSTEM



The ARKTECH VST SYSTEM is a self-supporting aluminium and stainless steel metal substructure kit for ventilated facades and designed for Arklam Slim 6 mm cladding. The system is composed of support and retention brackets, vertical profiles and staples on which the cladding rests, all in high quality Aluminium T5 6063.

By means of the supporting and retention brackets or separators, a correct planimetry of the vertical profiles is achieved, thus correcting any possible deviations from the original face of the façade to be covered.

The staples used to support the weight of the ceramic panels are made of aluminium and lacquered from the RAL of the porcelain tile, incorporating an EPDM bushing to absorb any expansion of the structure. Once fitted, the clamp can be slid vertically along the profile, thus facilitating its installation.

Finally, the clips are screwed to the vertical profile by means of self-drilling stainless steel screws. In order to favour the dimensional stability of the system, an elastic adhesive cord is applied along the vertical profile, which ensures the correct positioning of the chosen panels, improving the system's responses to pressure, wind suction and gravitational loads, thus absorbing the derived vibrations and thus avoiding possible movements.

ARKTECH VST SYSTEM es un kit de subestructura metálica de aluminio y acero inoxidable autoportante para fachadas ventiladas y diseñado para Arklam Slim 6 mm. El sistema está compuesto por ménsulas de sustentación y retención, perfiles verticales y grapas sobre las que se apoya el aplacado, todo en aluminio T5 6063 de alta calidad.

Por medio de las ménsulas o separadores de sustentación y retención se consigue una correcta planimetría de los perfiles verticales, corrigiendo así las posibles desviaciones del paramento original de la fachada a recubrir.

Las grapas encargadas de soportar el peso de los paneles cerámicos están fabricadas en aluminio y lacadas del RAL de la placa porcelanica, incorporan un casquillo de EPDM para absorber las posibles dilataciones de la estructura. Una vez encajada la grapa se puede deslizar en dirección vertical a lo largo del perfil facilitando así su instalación.

Finalmente, las grapas son atornilladas al perfil vertical por medio de tornillería autotaladrante de acero inoxidable. Para favorecer la estabilidad dimensional del sistema se aplica un cordón del adhesivo elástico a lo largo del perfil vertical, que asegura el correcto posicionamiento de los paneles escogidos mejorando las respuestas del sistema a las cargas de presión, succión de viento y gravitatorias, absorbiendo así las vibraciones derivadas y evitando con ello los posibles movimientos.

SYSTEM COMPONENTS / COMPONENTES DEL SISTEMA

ALUMINUM CHARACTERISTICS/ CARACTERÍSTICAS DEL ALUMINIO

DESIGNATION/ DESIGNACIÓN	
Symbolic/ Simbólica	EN AW -Al Mg Si
Numerical/ Numérica	6063
Treatment/ Tratamiento (Temple)	T -5
Code/ Norma	UNE-EN 755-2 ⁽¹⁾ , UNE-EN 12020-1 ⁽²⁾ y UNE-EN 12020-2 ⁽³⁾

PHYSICAL PROPERTIES/ PROPIEDADES FÍSICAS	
Specific weight/ Peso específico	2.700 Kg/m ³
Thermal dilatation coefficient/ Coeficiente dilatación térmica 20-100°C (1/K)	23,6 x 10 ⁻⁶ K ⁻¹ (20/100°C)
Elasticity module/ Módulo de elasticidad	69.500 N/mm ²
Poisson coefficient/ Coeficiente de Poisson	0,33

MECHANICAL PROPERTIES/ PROPIEDADES MECÁNICAS	
Tensile resistance (R _m)/ Resistencia a tracción (R _m)	215 N/mm ²
Shearing resistance/ Resistencia a la cizalladura	140 N/mm ²
Elastic limit/ Límite elástico (R _{p0,2%})	145 N/mm ²
Lengthening/ Alargamiento (L _{0-mm})	12%
Lengthening/ Alargamiento (L _{50mm})	14%
Brinell hardness/ Dureza Brinell	70

(1) UNE-EN 755-2:

Aluminum and aluminum alloys. Columns, tubes and extruded profiles. Part 2: mechanical characteristics
Aluminio y aleaciones de aluminio. Barras, tubos y perfiles extruidos. Parte 2: características mecánicas.

(2) UNE- EN 12020-1:

Aluminum and aluminum alloys. Special extruded profiles in alloys EN AW-6060 and EN AW-6063.

Part 1: Technical conditions for inspection and delivery.

Aluminio y aleaciones de aluminio. Perfiles extruidos especiales en aleaciones EN AW-6060 y EN AW-6063. Parte 1: Condiciones técnicas de inspección y suministro.

(3) UNE-EN 12020-2:

Aluminum and aluminum alloys. Special extruded profiles in alloys EN AW-6060 and EN AW-6063. Part 2: Dimensional and form tolerances.

Aluminio y aleaciones de aluminio. Perfiles extruidos en aleaciones EN AW-6060 y EN AW-6063. Parte 2: Tolerancias dimensionales y de forma.

ALUMINUM PROFILES / PERFILES DE ALUMINIO

Vertical profiles used in this system have a "T" and "L" shaped, and are made of, like brackets, in extruded aluminum from aluminum-magnesium-silica allow quality 6063 (Al Mg Si 0,5), with T-5 treatment. This kind of aluminum (6000 serial) is characterized by having a good resistance to corrosion.

Los perfiles verticales empleados en este sistema de fachada tienen sección en forma de "T" y "L", y están fabricados, al igual que las escuadras, en aluminio extruido de aleación aluminio-magnesio-silicio de calidad 6063 (Al Mg Si 0,5), con tratamiento T-5. Este tipo de aluminio (serie 6000) se caracteriza por tener una buena resistencia a la corrosión.

The geometrical and mechanical characteristics of the vertical profiles are:

Las características geométricas y mecánicas de los perfiles verticales son:

VERTICAL PROFILE CHARACTERISTICS/ CARACTERÍSTICAS DEL PERFIL VERTICAL									
PROFILE PERFIL	SECTION SECCIÓN (mm ²)	PERIMETER PERÍMETRO (mm)	WEIGHT PESO (kg/ml)	X AXIS/ EJE X			Y AXIS/ EJE Y		
				x _c (mm)	I _{xc} (cm ⁴)	r _{xc} (mm)	y _c (mm)	I _{yc} (cm ⁴)	r _{yc} (mm)
T 100X50X2	374.86	426.75	1.010	50.00	5.40	12	39.32	28.67	27.65
L 50X50X2	183.50	256.82	0.495	37.20	4.41	15.52	37.20	4.41	15.52

The tolerances are sought in the code UNE-EN 755-9⁽⁴⁾.
 (4) UNE-EN 755-9: Aluminum and aluminum alloys.
 Column, tubes and extruded profiles.
 Part 9: Profiles, dimensional and form tolerances.

Las tolerancias se establecen en la norma UNE-EN 755-9⁽⁴⁾.
 (4) UNE-EN 755-9: Aluminio y aleaciones de aluminio.
 Barras, tubos y perfiles extruidos.
 Parte 9: Perfiles, tolerancias dimensionales y de forma.

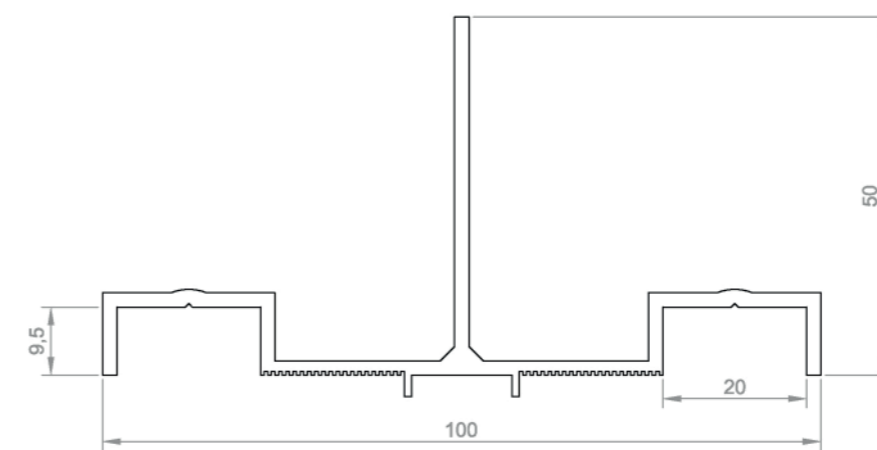

T striated profile/ Perfil T estriado
100x50x2 mm

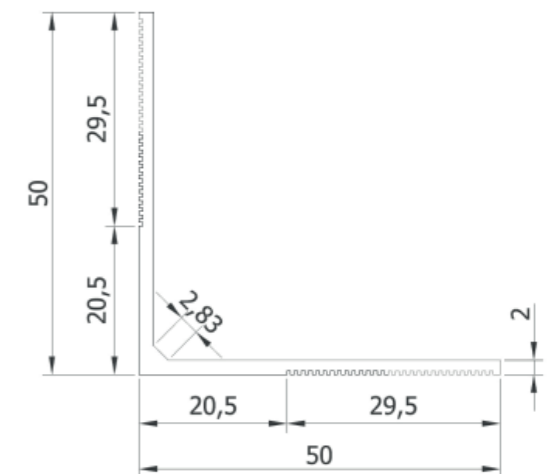

L striated profile/ Perfil L estriado
50x50x2 mm

ALUMINUM BRACKETS ESCUADRAS O MÉNSULAS DE ALUMINIO

The fixation system in framework edges and walls is done by adjustable support and retention brackets respectively. They are made of extruded aluminum, which is an alloy of aluminum-magnesium-silicon of 6063 quality (Al Mg Si 0'5), with T-5 treatment.

The brackets dimensions will vary depending on project because factors like facing planimetry to recover or width of air chamber influence in geometry of spacers used.

El sistema de fijación en los cantos de forjado y muros se realiza mediante escuadras regulables de sustentación y retención respectivamente. El material de que están fabricadas es aluminio extruido de aleación aluminio-magnesio-silicio de calidad 6063 (Al Mg Si 0,5), con tratamiento T-5.

Las dimensiones de las ménsulas variarán en función del proyecto a realizar ya que factores como la planimetría del paramento a recubrir o la anchura que se defina para la cámara de aire definirán la geometría de los separadores a utilizar.



Bracket/ Escuadra
150x65x50-350x3-5 mm



Bracket/ Escuadra
50x50x30-180x3 mm



Bracket/ Escuadra
100x65x50-350x3-5 mm

ADHESIVE / ADHESIVO

Are applied two cords of polyurethane mastic along to the T vertical profile and only one cord along to the L profile, particularly in striated areas of both profiles. The adhesive ensures correct positioning of panels improving the system response to gravity loads, pressure and suction wind loads, absorbing vibrations and thereby avoiding possible movements.

Also it is used double side tape when the vertical distance between the staples is greater than 1m, avoiding the buckling of the plates until the adhesive is cured.

Se aplican dos cordones de masilla de poliuretano a lo largo del perfil vertical en T y un único cordón en el perfil L, concretamente en la zona estriada del perfil. El adhesivo asegura el correcto posicionamiento de los paneles mejorando las respuestas del sistema a las cargas gravitatorias, cargas de presión y de succión de viento, absorbiendo las vibraciones y evitando con ello los posibles clapeteos.

También se debe utilizar cinta de doble cara cuando la distancia vertical entre las grapas es superior a 1 m, evitando así el pandeo de las placas hasta que el adhesivo esté curado.



ALUMINUM STAPLES GRAPAS DE ALUMINIO



Coronation/ Start VST-7
Coronación/ Arranque VST-7

The staples to mechanical fixation are made of extruded aluminum from aluminum-magnesium-silica alloy quality 6063 (Al Mg Si 0,5), with T-5 treatment.

There are two models of staples depending on their placement on the facade.

Start/end Staple CLF-40/7mm.
Intermediate Staple CLF-40/7mm.

Below are shown graphically the different staples that are available. The staples have an EPDM joint for a better coupling between facing and staples and in order to avoid movements due to wind action.

Las grapas para la fijación mecánica están fabricadas en aluminio extruido de aleación aluminio-magnesio-silicio de calidad 6063 (Al Mg Si 0,5), con tratamiento T-5.

Existen dos modelos de grapas dependiendo de su colocación en la fachada.

Grapa de arranque/coronación CLF-40/7mm.
Grapa intermedia CLF-40/7mm.

A continuación se muestran gráficamente las diferentes grapas disponibles. Las grapas disponen de una junta de EPDM para un mejor acoplamiento del aplacado a la grapa y con la finalidad de evitar clapeteos debidos a la acción del viento.

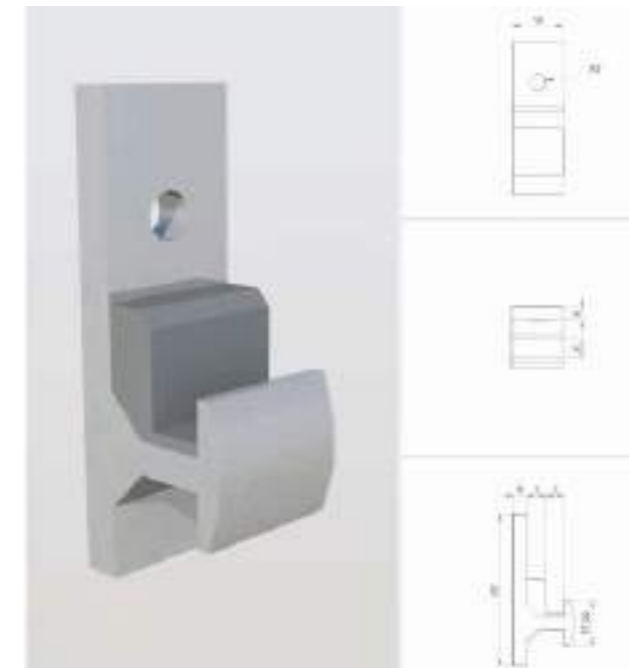

Intermediate VST-7
Intermedia VST-7

MECHANICAL FIXATION ELEMENTS ELEMENTOS DE FIJACIÓN MECÁNICA

FIXATION OF VERTICAL PROFILES TO BRACKETS:

For fixing the vertical profile to the brackets used self-drilling screws of hexagonal head, DIN 7504K, made of stainless steel A2/A4. The screws normally used are as follows:

Ø6,3 mm y lenght L=25 mm. For fixed points of the support brackets.

Ø6,3 mm y lenght L=25 mm with washer of EPDM. For floating points of the support brackets.

Ø4,8mm y lenght L=19 mm with washer of EPDM. For floating points of the retention brackets.

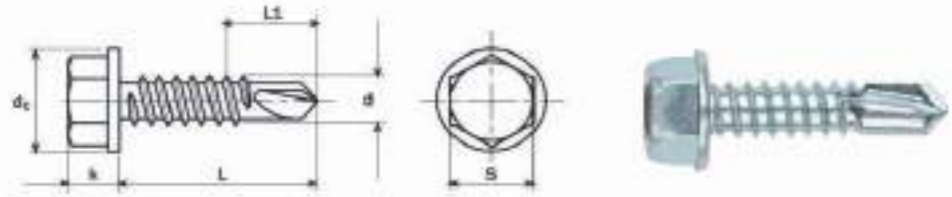

FIXATION THE BRACKETS TO THE ENCLOSURE:

The definition of the type and number of anchorages for fixing the brackets to the support is made depending on the base material and the transmitted stress to it in each case. However the anchors normally used are:

Expansive metal anchors in reinforced concrete slab (ø8x90 mm o ø10x90 mm), 2 ud in the support bracket.



Sometimes, it is necessary to anchor the support bracket to areas where there is no concrete slab (some outlines of windows, high-rise windowsills, cantilevers, overhangs...). Faced with this situation, a nylon plug set is used FL 10x90 mm, stainless A-2, forming by screw DIN 571 8x100 mm stainless A-2, a nylon plug FL 10x90 mm and a washer M-8 9021 stainless A-2.



Depending on the type and strenght of the enclosure, it may be more appropriate and/or necessary the use of other type of nylon plug or a chemical anchor with threaded rod (consisting of a threaded rod 8x120 stainless A2, sieve of 12x80 and polyester resin without styrene).

FIJACIÓN DE LOS PERFILES VERTICALES A LOS SEPARADORES:

Para la fijación del perfil vertical a los separadores se utiliza tornillería autotaladrante de cabeza hexagonal, DIN 7504K, fabricados en acero inoxidable A2/A4. Se utilizan por regla general los siguientes:

Ø6,3 mm y longitud L=25 mm. Para los puntos fijos de las escuadras de sustentación.

Ø6,3 mm y longitud L=25 mm con arandela de EPDM. Para los puntos flotantes de las escuadras de sustentación.

Ø4,8mm y longitud L=19 mm con arandela de EPDM. Para los puntos flotantes de las escuadras de retención

FIJACIÓN DE LOS SEPARADORES AL SOPORTE:

La definición del tipo y número de anclajes para la fijación de los separadores al soporte se realizará en función del material base y los esfuerzos transmitidos al mismo en cada caso. No obstante de forma general los anclajes que se utilizarán serán:

Anclajes metálicos expansivos en forjados de hormigón armado (Ø8x90 mm o Ø10x90 mm), 2 ud en la escuadra de sustentación.

En ciertos casos, resulta necesario anclar la ménsula de sustentación a zonas en las que no hay forjado (algunos contornos de ventana, antepechos de gran altura, voladizos, salientes...). Frente a esta situación, se recurre a un conjunto taco nylon FL 10x90 mm, inoxidable A-2, formado por un tornillo DIN 571 8x100 mm inoxidable A-2, un taco de nylon FL 10x90 mm y una arandela M-8 9021 inoxidable A-2.

Según la tipología y la resistencia del cerramiento, podría resultar más adecuado y/o necesario el uso de otro tipo de taco nylon o de un anclaje químico con varilla roscada (compuesto por una varilla roscada 8x120 inoxidable A2, tamiz de 12x80 y resina de poliéster sin estireno).

DETAILED DRAWINGS OF ARKTECH GL SYSTEM SECTIONS PLANOS DETALLE DE SECCIONES DE ARKTECH GL SYSTEM

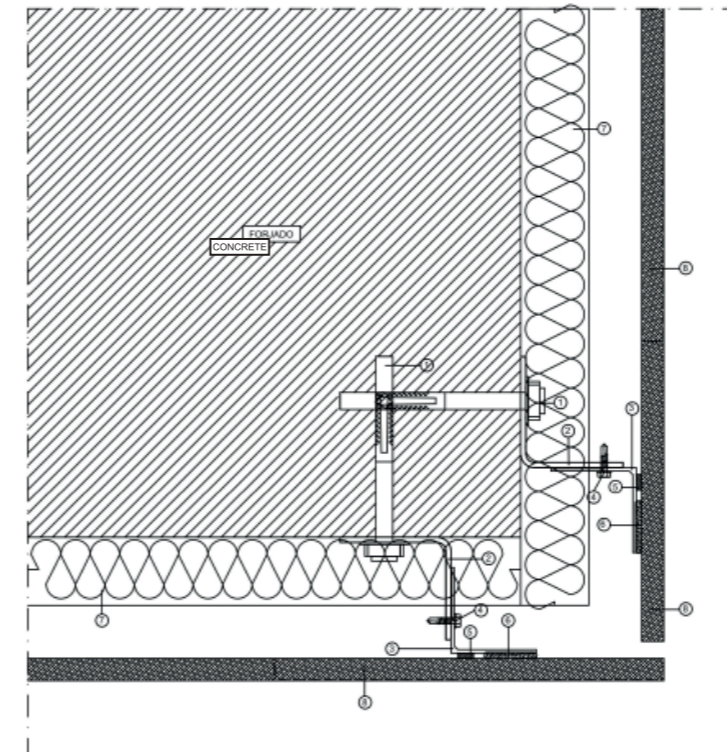

HORIZONTAL SECTION/ SECCIÓN HORIZONTAL

1. MTA anchor 10x90 stainless steel A2
2. ESC aluminium 50x50x60x3
3. Profile L 50X50X2 ribbed
4. Screw DIN 7504-K 6.3x25 stainless steel A2
5. Double-sided adhesive tape (FoamTape)
6. PanelTack-HM Glue
7. Insulation
8. External cladding

1. Anclaje MTA 10x90 inox A2
2. ESC aluminio 50x50x60x3
3. Perfil L 50X50X2 estriada
4. Tornillo DIN 7504-K 6.3x25 inox A2
5. Cinta adhesiva doble cara (FoamTape)
6. Pegamento PanelTack-HM
7. Aislante
8. Revestimiento exterior

HORIZONTAL SECTION/ SECCIÓN HORIZONTAL

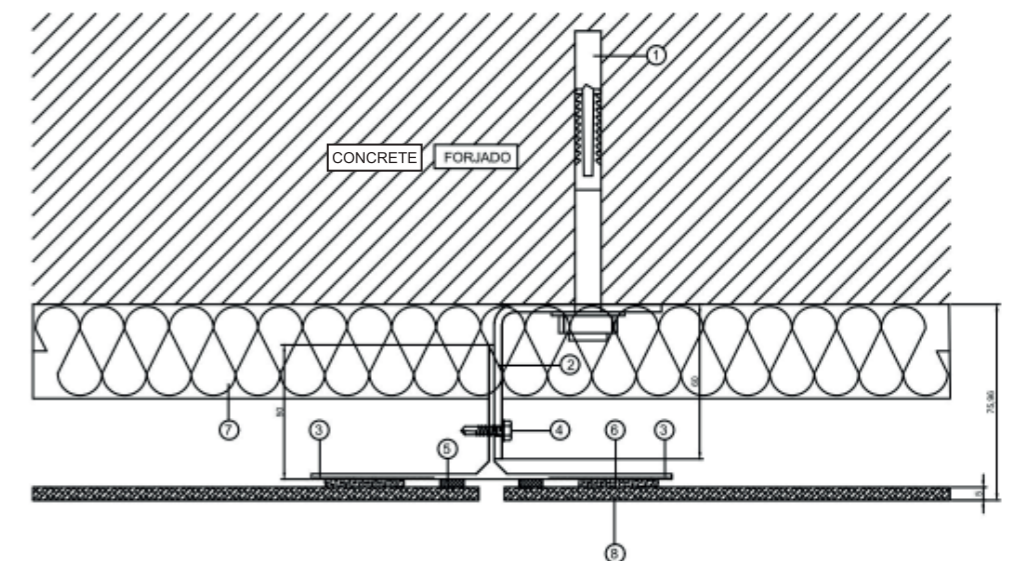

1. MTA anchor 10x90 stainless steel A2
2. ESC aluminium 150x65x60x3
3. Vertical aluminium profile "T 110x50x2".
4. Screw DIN 7504-K 6.3x25 stainless steel A2
5. Double-sided adhesive tape (FoamTape)
6. PanelTack-HM Glue
7. Insulation
8. Internal cladding

1. Anclaje MTA 10x90 inox A2
2. ESC aluminio 150x65x60x3
3. Perfil vertical aluminio "T 110x50x2"
4. Tornillo DIN 7504-K 6.3x25 inox A2
5. Cinta adhesiva doble cara (FoamTape)
6. Pegamento PanelTack-HM
7. Aislante
8. Revestimiento interior

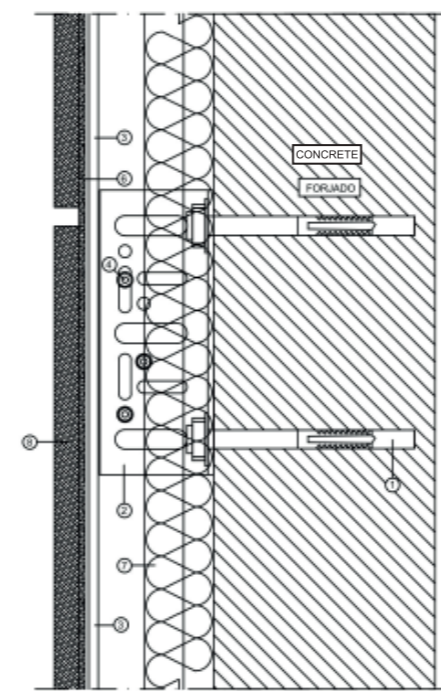

VERTICAL SECTION SECCIÓN VERTICAL

ARKTECH FULL SYSTEM

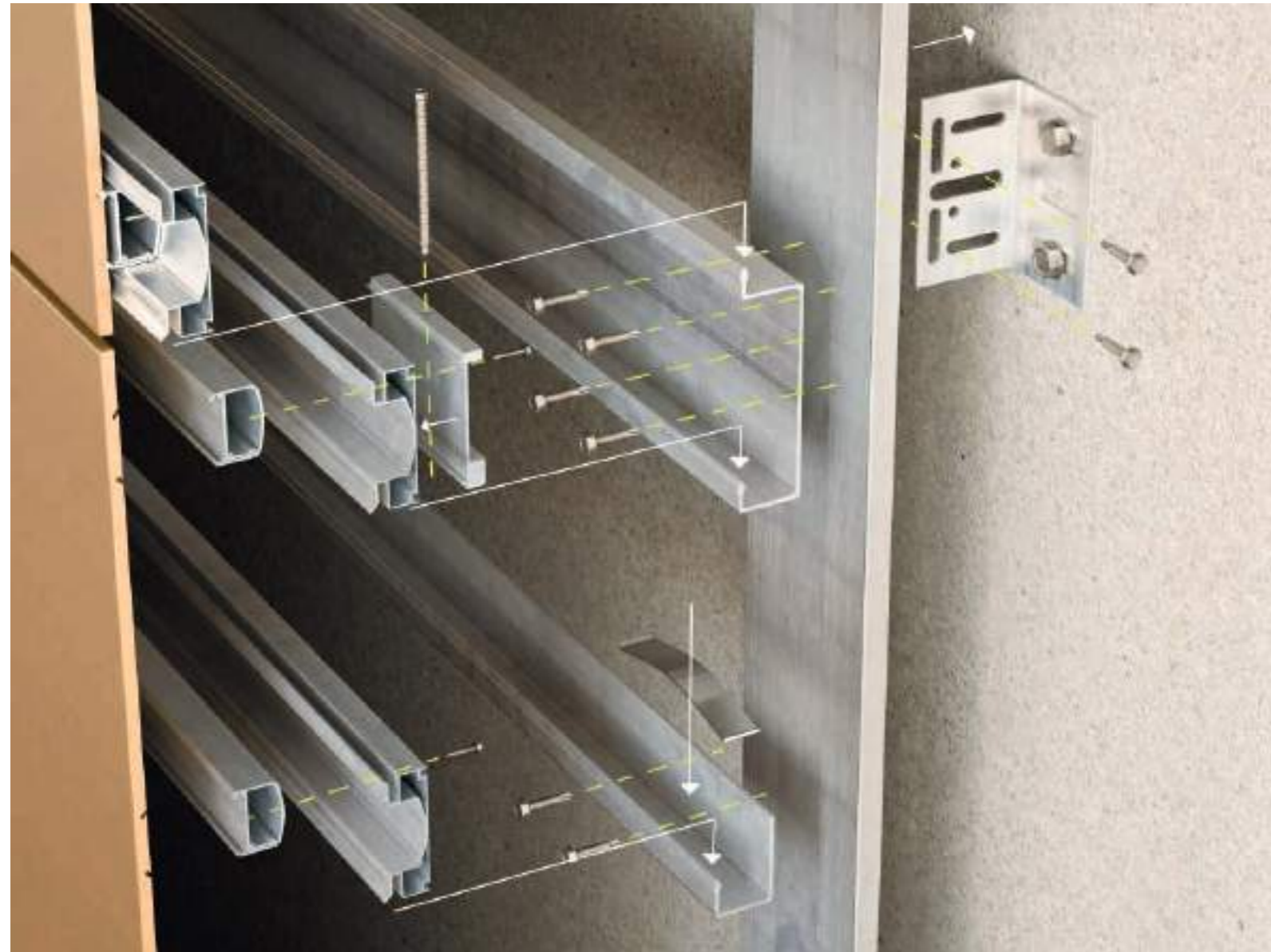

ARKTECH FULL SYSTEM, for the installation of Arklam Slim 6 mm. The main features are:

Innovative design of discontinuous longitudinal anchors located on the back of the plate, with double groove at 45° in dovetail, which allow a union of the fixing elements to the plate in a 100% mechanical form. The system is designed to be installed only with mechanical fixation, however its geometry allows the application of a structural adhesive, offering a safety bonus through a combined fixation system (mechanical-chemical).

Self-compensing system by means of stainless steel compression springs which allow to assimilate the deformations due to expansion of the substructure, in addition these springs contribute to support the own weight of the plate.

Regulation mechanisms for a perfect regulation of the plate as well as the perfect support of the vertical loads in these regulation elements, thus obtaining an equitable distribution of these loads.

ARKTECH FULL SYSTEM, para la instalación de Arklam Slim 6 mm. Las características principales son:

Innovador diseño de anclajes longitudinales discontinuos ubicados en el dorso de la placa, de doble ranura a 45° en cola de milano, las cuales permiten una unión de los elementos de fijación a la placa de forma 100% mecánica. El sistema está concebido para ser instalado únicamente con fijación mecánica, no obstante su geometría permite la aplicación de un adhesivo estructural, ofreciendo un plus de seguridad mediante un sistema de fijación combinado (mecánico-químico).

Sistema autocompensante mediante resortes de compresión de acero inoxidable los cuales permiten asimilar las deformaciones por dilatación de la subestructura, además dichos resortes contribuyen a soportar el peso propio de la placa.

Mecanismos de regulación para una perfecta regulación de la placa así como del perfecto apoyo de las cargas verticales en dichos elementos de regulación, obteniendo así un reparto equitativo de dichas cargas.

SYSTEM COMPONENTS / COMPONENTES DEL SISTEMA

ALUMINUM CHARACTERISTICS/ CARACTERÍSTICAS DEL ALUMINIO

DESIGNATION/ DESIGNACIÓN	
Symbolic/ Simbólica	EN AW -Al Mg Si
Numerical/ Numérica	6063
Treatment/ Tratamiento (Temple)	T -5
Code/ Norma	UNE-EN 755-2 ⁽¹⁾ , UNE-EN 12020-1 ⁽²⁾ y UNE-EN 12020-2 ⁽³⁾

PHYSICAL PROPERTIES/ PROPIEDADES FÍSICAS

Specific weight/ Peso específico	2.700 Kg/m ³
Thermal dilatation coefficient/ Coeficiente dilatación térmica 20-100°C (1/K)	23,6 x 10 ⁻⁶ K ⁻¹ (20/100°C)
Elasticity module/ Módulo de elasticidad	69.500 N/mm ²
Poisson coefficient/ Coeficiente de Poisson	0,33

MECHANICAL PROPERTIES/ PROPIEDADES MECÁNICAS

Tensile resistance (R _m)/ Resistencia a tracción (R _m)	215 N/mm ²
Shearing resistance/ Resistencia a la cizalladura	140 N/mm ²
Elastic limit/ Límite elástico (R _{p0,2%})	145 N/mm ²
Lengthening/ Alargamiento (L _{0-mm})	12%
Lengthening/ Alargamiento (L _{50mm})	14%
Brinell hardness/ Dureza Brinell	70

(1) UNE-EN 755-2:

Aluminum and aluminum alloys. Columns, tubes and extruded profiles. Part 2: mechanical characteristics
Aluminio y aleaciones de aluminio. Barras, tubos y perfiles extruidos. Parte 2: características mecánicas.

(2) UNE-EN 12020-1:

Aluminum and aluminum alloys. Special extruded profiles in alloys EN AW-6060 and EN AW-6063.

Part 1: Technical conditions for inspection and delivery.

Aluminio y aleaciones de aluminio. Perfiles extruidos especiales en aleaciones EN AW-6060 y EN AW-6063.
Parte 1: Condiciones técnicas de inspección y suministro.

(3) UNE-EN 12020-2:

Aluminum and aluminum alloys. Special extruded profiles in alloys EN AW-6060 and EN AW-6063. Part 2: Dimensional and form tolerances.

Aluminio y aleaciones de aluminio. Perfiles extruidos en aleaciones EN AW-6060 y EN AW-6063. Parte 2: Tolerancias dimensionales y de forma.



This system consists of sustentation and retention brackets, staples, vertical T-profiles and horizontal profiles with geometry designed exclusively for this purpose.

Thanks to the brackets it is possible to achieve the correct levelling of the vertical profiles, and in this way, we can be sure that possible deviations from the original surface of the façade to be covered are being corrected.

The horizontal hanging profile is connected to the vertical profiles by means of self-drilling screws with hexagonal heads made of A2 stainless steel.

The staples of internal fixation in Aluminium, are anchored on the longitudinal discontinuous grooves in the shape of dovetail (at 45°), located in the back part of the porcelain tile, allowing a 100% mechanical fixation.

A continuous horizontal profile of pressure closing joins the system of fixing clamps, by means of A2 self-drilling screws, thus forming a body between the fixing clamp and the continuous horizontal profile, for subsequent assembly on horizontal hanging profile located in the substructure, with the possibility of being able to regulate the plate, thanks to its regulation mechanism, making the installation of the system possible in a simple, efficient and above all safe manner.

The system is designed to be installed only with mechanical fixing, however its geometry allows the application of a structural adhesive, offering a safety bonus through a combined fixing system (mechanical-chemical).

The assembly has a system of SELF-COMPENSATION by means of stainless steel compression springs, which allow to assimilate the deformations by expansion of the substructure. In addition, these springs contribute to support the own weight of the plate.

ALUMINUM BRACKETS / ESCUADRAS O MÉNSULAS DE ALUMINIO

The fixation system in framework edges and walls is done by adjustable support and retention brackets respectively. They are made of extruded aluminum, which is an alloy of aluminum-magnesium-silicon of 6063 quality (Al Mg Si 0'5), with T-5 treatment.

The brackets dimensions will vary depending on project because factors like facing planimetry to recover or width of air chamber influence in geometry of spacers used.

Este sistema se compone de ménsulas de soporte y retención, grapas, perfiles verticales en forma de "T" y perfiles horizontales.

Gracias a las escuadras es posible conseguir la correcta nivelación de los perfiles verticales y, de esta forma, podemos estar seguros de que se están corrigiendo las posibles desviaciones de la superficie original de la fachada que se ha de cubrir.

El perfil horizontal de cuelgue está unido a la perfilería vertical por medio de tornillería autotaladrante de cabeza hexagonal fabricada en acero inoxidable A2.

Las grapas de fijación interna en aluminio se anclan sobre las ranuras discontinuas longitudinales en forma de cola de milano (a 45°), ubicadas en la parte posterior del azulejo porcelánico, permitiendo una fijación 100% mecánica.

Un perfil horizontal continuo de cierre a presión une el sistema de grapas de fijación mediante unos tornillos auto perforantes A2 formando así un cuerpo entre la grapa de fijación y el perfil horizontal continuo, para su posterior montaje sobre perfil horizontal de cuelgue ubicado en la subestructura, con la posibilidad de poder regular la placa gracias a su mecanismo de regulación, haciendo que la instalación del sistema se pueda realizar de una manera sencilla eficaz y ante todo segura.

El sistema está concebido para ser instalado únicamente con fijación mecánica, no obstante su geometría permite la aplicación de un adhesivo estructural, ofreciendo un plus de seguridad mediante un sistema de fijación combinado (mecánico-químico).

El conjunto posee un sistema de autocompensación mediante resortes de compresión de acero inoxidable, los cuales permiten asimilar las deformaciones por dilatación de la subestructura. Además, dichos resortes contribuyen a soportar el peso propio de la placa.

El sistema de fijación en los cantos de forjado y muros se realiza mediante escuadras regulables de sustentación y retención respectivamente. El material de que están fabricadas es aluminio extruido de aleación aluminio-magnesio-silicio de calidad 6063 (Al Mg Si 0,5), con tratamiento T-5.

Las dimensiones de las ménsulas variarán en función del proyecto a realizar ya que factores como la planimetría del paramento a recubrir o la anchura que se defina para la cámara de aire definirán la geometría de los separadores a utilizar.



Bracket/ Escuadra
150x65x50-350x3-5 mm



Bracket/ Escuadra
50x50x30-180x3 mm



Bracket/ Escuadra
100x65x50-350x3-5 mm

Vertical profiles used in this system have a "T" and "L" shaped, and are made of, like brackets, in extruded aluminum from aluminum-magnesium-silica alloy quality 6063 (Al Mg Si 0,5), with T-5 treatment. This kind of aluminum (6000 series) is characterized by having a good resistance to corrosion.

Los perfiles verticales empleados en este sistema de fachada tienen sección en forma de "T" y "L", y están fabricados, al igual que las escuadras, en aluminio extruido de aleación aluminio-magnesio-silicio de calidad 6063 (Al Mg Si 0,5), con tratamiento T-5. Este tipo de aluminio (serie 6000) se caracteriza por tener una buena resistencia a la corrosión.

The geometrical and mechanical characteristics of the vertical profiles are:

Las características geométricas y mecánicas de los perfiles verticales son:

VERTICAL PROFILE CHARACTERISTICS/ CARACTERÍSTICAS DEL PERFIL VERTICAL									
PROFILE PERFIL	SECTION SECCIÓN (mm ²)	PERIMETER PERÍMETRO (mm)	WEIGHT PESO (kg/ml)	X AXIS/ EJE X			Y AXIS/ EJE Y		
				x _c (mm)	I _{xc} (cm ⁴)	r _{xc} (mm)	y _c (mm)	I _{yc} (cm ⁴)	r _{yc} (mm)
T 110X50X2	303.00	386.65	0.818	55.00	5.91	13.98	41.02	19.66	25.48

The tolerances are sought in the code UNE-EN 755-9⁽⁴⁾.
 (4) UNE-EN 755-9: Aluminum and aluminum alloys.
 Column, tubes and extruded profiles.
 Part 9: Profiles, dimensional and form tolerances.

Las tolerancias se establecen en la norma UNE-EN 755-9⁽⁴⁾.
 (4) UNE-EN 755-9: Aluminio y aleaciones de aluminio.
 Barras, tubos y perfiles extruidos.
 Parte 9: Perfiles, tolerancias dimensionales y de forma.

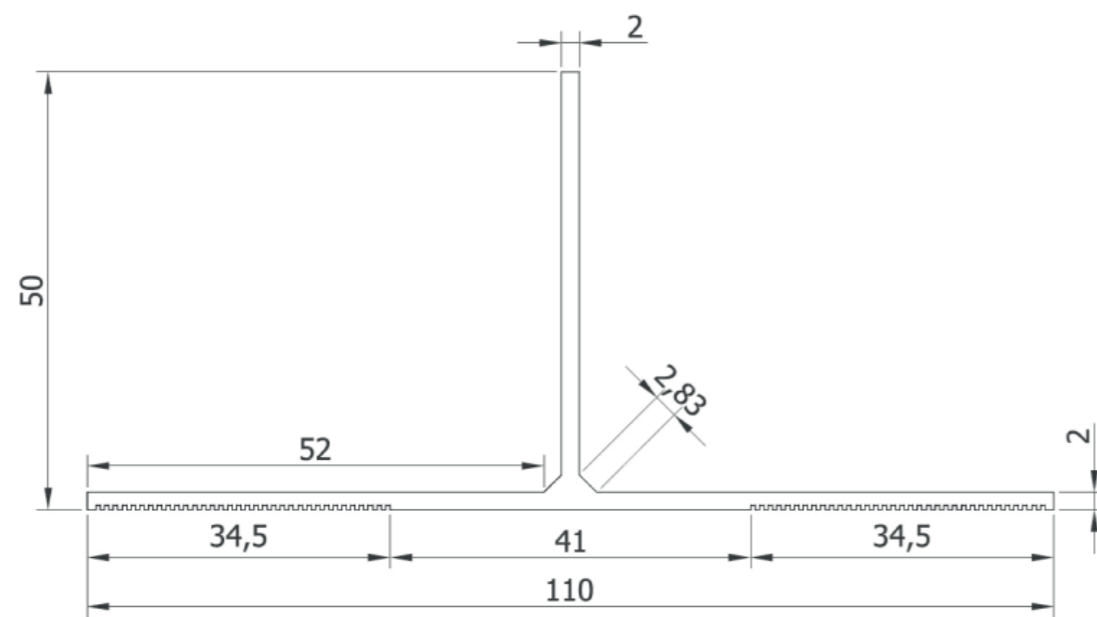

T striated profile/ Perfil T estriado
110x50x2 mm

OUTER AND INNER HORIZONTAL ALUMINUM PROFILES PERFILES DE ALUMINIO HORIZONTALES EXTERIORES E INTERIORES

The geometrical and mechanical characteristics of the vertical profiles are:

Las características geométricas y mecánicas de los perfiles verticales son:

VERTICAL PROFILE CHARACTERISTICS/ CARACTERÍSTICAS DEL PERFIL VERTICAL									
PROFILE PERFIL	SECTION SECCIÓN (mm ²)	PERIMETER PERÍMETRO (mm)	WEIGHT PESO (kg/ml)	X AXIS/ EJE X			Y AXIS/ EJE Y		
				x _c (mm)	I _{xc} (cm ⁴)	r _{xc} (mm)	y _c (mm)	I _{yc} (cm ⁴)	r _{yc} (mm)
Continuo simple	221.71	208.08	0.599	21.83	4.86	14.80	35.77	43.10	13.94
Continuo doble	449.33	412.00	1.213	23.59	94.67	45.90	70.89	7.98	13.33
Externo continuo	277.20	476.41	0.748	15.77	16.48	24.38	36.02	2.04	8.57
Grapa interna (a)	188.80	235.40	0.510	15.71	3.26	13.14	20.42	1.41	8.64
Grapa interna lateral (b)	39.49	54.19	0.107	10.98	0.00326	0.909	2.65	0.16146	6.394

The tolerances are sought in the code UNE-EN 755-9⁽⁴⁾.
 (4) UNE-EN 755-9: Aluminum and aluminum alloys.
 Column, tubes and extruded profiles.
 Part 9: Profiles, dimensional and form tolerances.

Las tolerancias se establecen en la norma UNE-EN 755-9⁽⁴⁾.
 (4) UNE-EN 755-9: Aluminio y aleaciones de aluminio.
 Barras, tubos y perfiles extruidos.
 Parte 9: Perfiles, tolerancias dimensionales y de forma.

OUTER AND INNER HORIZONTAL ALUMINUM PROFILES
PERFILES DE ALUMINIO HORIZONTALES EXTERIORES E INTERIORES

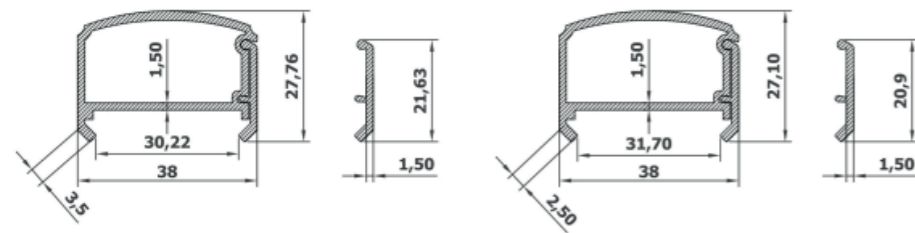

Continuous horizontal profile / Perfil horizontal continuo

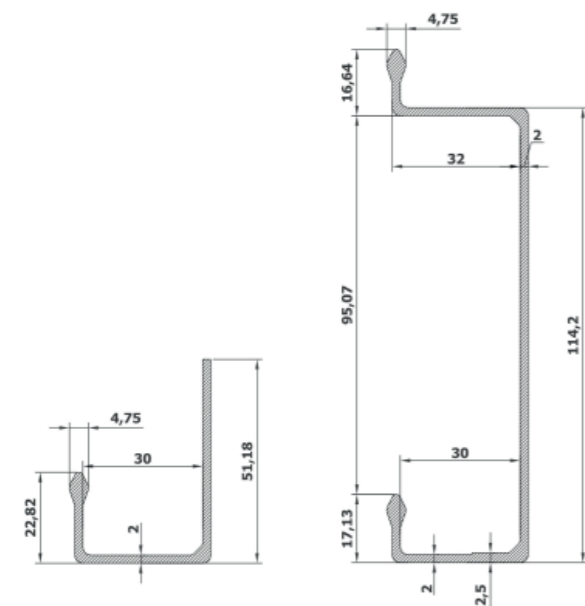

Profile single and double continuous / Perfiles continuos doble-simple

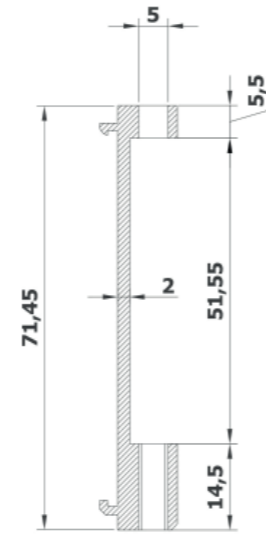

Regulation complement
 Complemento de regulación

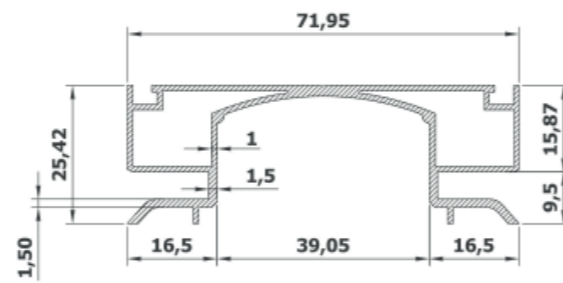

Profile external continuous / Perfil externo continuo

SPRINGS/MUELLE DE PRESIÓN

It has a SELF-COMPENSING system by means of stainless steel compression springs, which allow to assimilate the deformations due to the expansion of the substructure, in addition these springs contribute to support the own weight of the plate.

The springs are made of stainless Steel AISI 301.

Dispone de un sistema de autocompactación mediante muelles de compresión de acero inoxidable, que permiten asimilar las deformaciones debidas a la dilatación de la subestructura, además de que estos muelles contribuyen a soportar el peso propio de la placa.

El muelle está fabricado en acero inoxidable AISI 301.

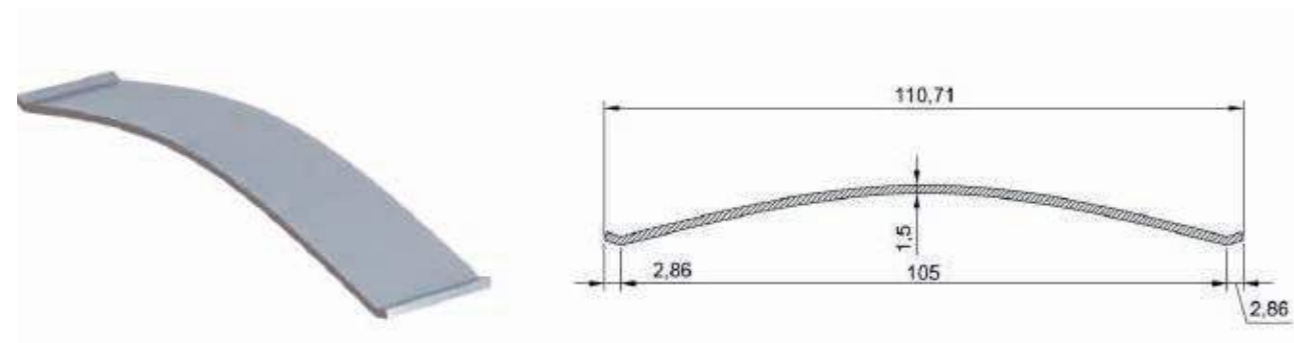

COMPLEMENT OF LEVEL REGULATION
COMPLEMENTO DE REGULACIÓN

The REGULATION complement is a piece that by means of a screw allows us to level the plates in the placement of the façade.

El complemento de regulación es una pieza que mediante un tornillo nos permite poder nivelar las placas en la colocación de la fachada.

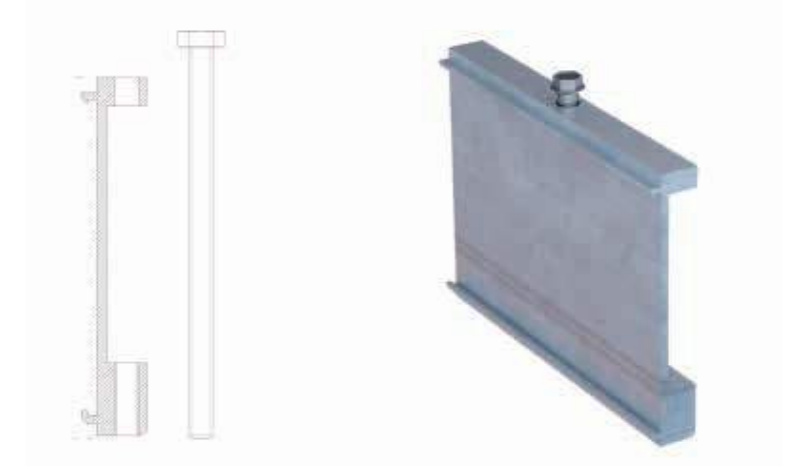

MECHANICAL FIXATION ELEMENTS
ELEMENTOS DE FIJACIÓN MECÁNICA

FIXATION OF VERTICAL PROFILES TO BRACKETS:

For fixing the vertical profile to the brackets used self-drilling screws of hexagonal head, DIN 7504K, made of stainless steel A2/A4. The screws normally used are as follows:

Ø6,3 mm y length L=25 mm. For fixed points of the support brackets.

Ø6,3 mm y length L=25 mm with washer of EPDM. For floating points of the support brackets.

Ø4,8mm y length L=19 mm with washer of EPDM. For floating points of the retention brackets.

FIJACIÓN DE LOS PERFILES VERTICALES A LOS SEPARADORES:

Para la fijación del perfil vertical a los separadores se utiliza tornillería autotaladrante de cabeza hexagonal, DIN 7504K, fabricados en acero inoxidable A2/A4. Se utilizan por regla general los siguientes:

Ø6,3 mm y longitud L=25 mm. Para los puntos fijos de las escuadras de sustentación.

Ø6,3 mm y longitud L=25 mm con arandela de EPDM. Para los puntos flotantes de las escuadras de sustentación.

Ø4,8mm y longitud L=19 mm con arandela de EPDM. Para los puntos flotantes de las escuadras de retención

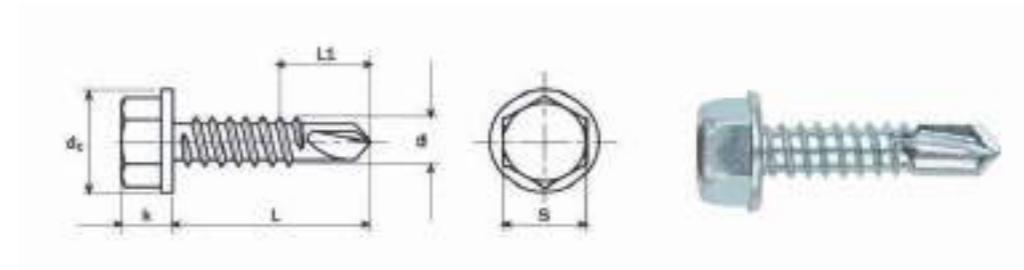

ASSEMBLY SEQUENCE INSIDE CLAMP WITH CONTINUOUS UNION PROFILE
SECUENCIA DE MONTAJE DE LA GRAPA INTERIOR CON PERFIL DE UNIÓN CONTINUA

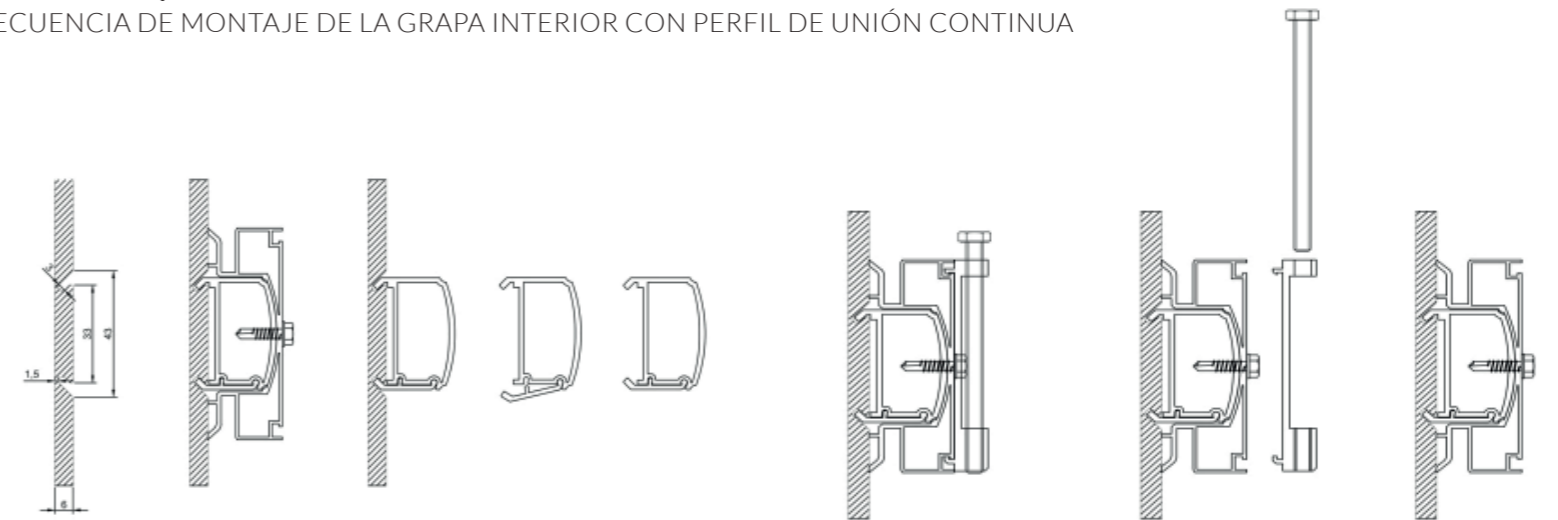

FASTENING OF THE STAPLES TO THE VERTICAL PROFILES:

To fix the clips to the vertical profiles, extra-flat self-drilling screws are used, made of A2 stainless steel with a diameter of Ø4.2 mm and a length of L=14 mm.

FIXATION THE BRACKETS TO THE ENCLOSURE:

The definition of the type and number of anchorages for fixing the brackets to the support is made depending on the base material and the transmitted stress to it in each case. However, the anchors normally used are:

Expansive metal anchors in reinforced concrete slab (Ø8x90 mm or Ø10x90 mm), 2 units in the support bracket.



Sometimes, it is necessary to anchor the support bracket to areas where there is no concrete slab (some outlines of windows, high-rise windowsills, cantilevers, overhangs...). Faced with this situation, a nylon plug set is used, FL 10x901 mm, stainless A2, forming a screw DIN 571 8x100 mm stainless A-2, a nylon plug FL 10x90 mm and a washer M-8 9021 stainless A-2.



Depending on the type and strength of the enclosure, it may be more appropriate and/or necessary the use of another type of nylon plug or a chemical anchor with threaded rod (consisting of a threaded rod 8x120 stainless A2, a sieve of 12x80 and polyester resin without styrene).

REGULATION COMPLEMENT SCREW / TORNILLO DE COMPLEMENTO DE REGULACIÓN

DIN-933 Threaded screw M6 x 80 with hexagon head Complete thread A2
DIN-933 Tornillo M6 x 80 con cabeza hexagonal, rosca completa A2



FIJACIÓN DE LAS GRAPAS A LOS PERFILES VERTICALES:

Para la fijación de las grapas a los perfiles verticales se utiliza tornillería autotaladrante de cabeza extraplana, fabricados en acero inoxidable A2 de diámetro Ø4,2 mm y longitud L=14 mm.

FIJACIÓN DE LOS SEPARADORES AL SOPORTE:

La definición del tipo y número de anclajes para la fijación de los separadores al soporte se realizará en función del material base y los esfuerzos transmitidos al mismo en cada caso. No obstante de forma general los anclajes que se utilizarán serán:

Anclajes metálicos expansivos en forjados de hormigón armado (Ø8x90 mm o Ø10x90 mm), 2 ud en la escuadra de sustentación.

En ciertos casos, resulta necesario anclar la ménsula de sustentación a zonas en las que no hay forjado (algunos contornos de ventana, antepechos de gran altura, voladizos, salientes...). Frente a esta situación, se recurre a un conjunto taco nylon FL 10x90 mm, inoxidable A-2, formado por un tornillo DIN 571 8x100 mm inoxidable A-2, un taco de nylon FL 10x90 mm y una arandela M-8 9021 inoxidable A-2.

Según la tipología y la resistencia del cerramiento, podría resultar más adecuado y/o necesario el uso de otro tipo de taco nylon o de un anclaje químico con varilla roscada (compuesto por una varilla roscada 8x120 inoxidable A2, tamiz de 12x80 y resina de poliéster sin estireno).

DETAILED DRAWINGS OF ARKTECH GL SYSTEM SECTIONS PLANOS DETALLE DE SECCIONES DE ARKTECH GL SYSTEM

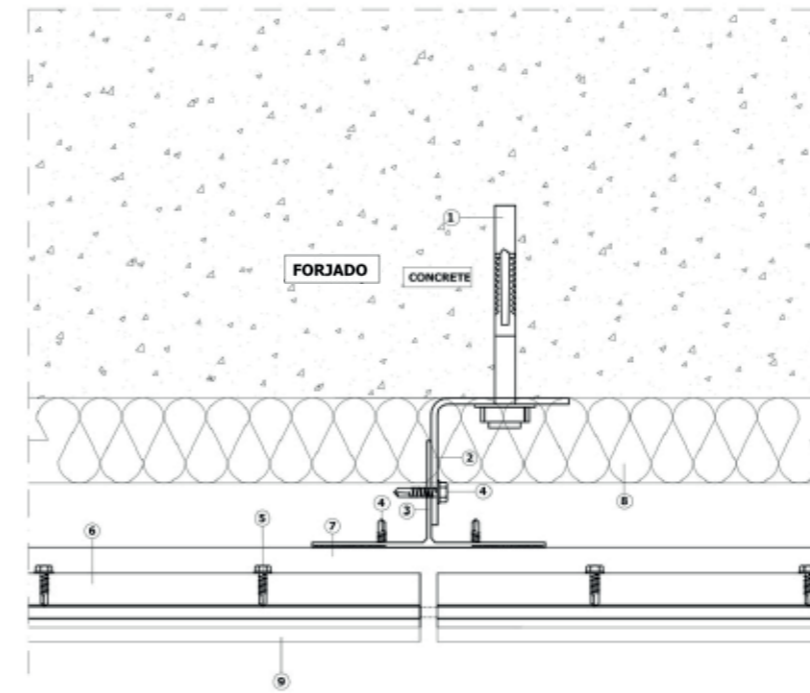

HORIZONTAL SECTION/ SECCIÓN HORIZONTAL

1. Anchorage MTA 8x90 stainless A2
2. Aluminum bracket 150x65x60x3
3. Aluminum vertical profile T 110x50x2
4. Screw DIN 7504-K 6.3x25 stainless steel A2
5. Screw DIN 7504-K 4.8x16 stainless steel A2
6. External profile union Arktech Full System
7. Continuous profile double Arktech Full System
8. Insulation
9. Exterior cladding

1. Anclaje MTA 8x90 inox A2
2. Escuadra de aluminio 150x65x60x3
3. Perfil vertical aluminio T 110x50x2
4. Tornillo DIN 7504-K 6.3x25 inox A2
5. Tornillo DIN 7504-K 4.8x16 inox A2
6. Perfil exterior Arktech Full System
7. Perfil continuo (doble o simple) Arktech Full System
8. Aislante
9. Revestimiento exterior

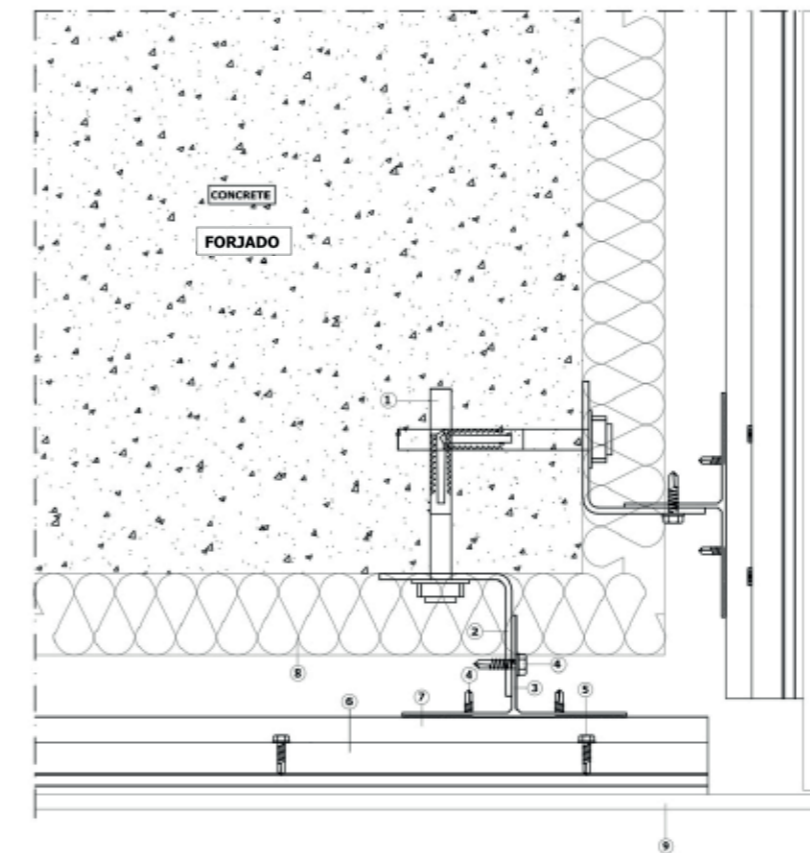

HORIZONTAL SECTION/ SECCIÓN HORIZONTAL

1. Anchorage MTA 8x90 stainless A2
2. Aluminum bracket 150x65x60x3
3. Aluminum vertical profile T 110x50x2
4. Screw DIN 7504-K 6.3x25 stainless steel A2
5. Screw DIN 7504-K 4.8x16 stainless steel A2
6. Internal clamp Arktech Full System
7. Continuous profile (double or single) Arktech Full System
8. Insulation
9. Exterior cladding

1. Anclaje MTA 8x90 inox A2
2. Escuadra de aluminio 150x65x60x3
3. Perfil vertical aluminio T 110x50x2
4. Tornillo DIN 7504-K 6.3x25 inox A2
5. Tornillo DIN 7504-K 4.8x16 inox A2
6. Grapa exterior Arktech Full System
7. Perfil continuo (doble o simple) Arktech Full System
8. Aislante
9. Revestimiento exterior

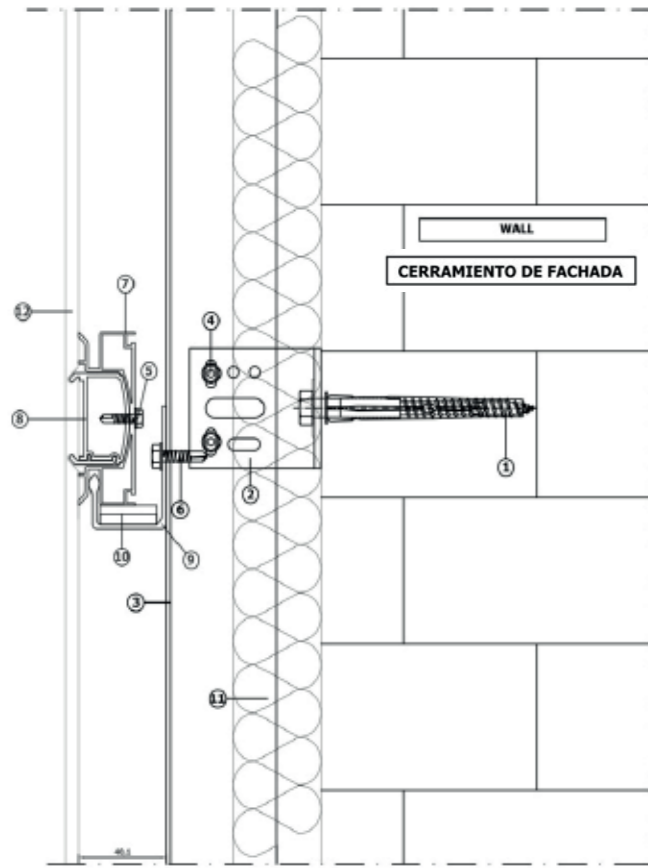

VERTICAL SECTION/ SECCIÓN VERTICAL

1. Anchorage taco-nylon set
2. Aluminum bracket 50x50x60x3
3. Aluminum vertical profile T 110x50x2
4. Screw DIN 7504-K 4.7x25 stainless steel A2 with washer EPDM
5. Screw DIN 7504-K 4.8x16 stainless steel A2
6. Screw DIN 7504-K 6.3x25 stainless steel A2
7. External profile union Arktech Full System
8. Internal clamp Arktech Full System
9. Single continuous profile Arktech Full System
10. Self-compensating spring of loads Arktech Full System
11. Insulation
12. Exterior cladding

1. Anclaje taco-nylon set
2. Escuadra de aluminio 50x50x60x3
3. Perfil vertical aluminio T 110x50x2
4. Tornillo DIN 7504-K 4.7x25 inox A2 con arandela EPDM
5. Tornillo DIN 7504-K 4.8x16 inox A2
6. Tornillo DIN 7504-K 6.3x25 inox A2
7. Perfil exterior Arktech Full System
8. Grapa interior Arktech Full System
9. Perfil continuo simple Arktech Full System
10. Muelle autocompensante de cargas Arktech Full System
11. Aislante
12. Revestimiento exterior

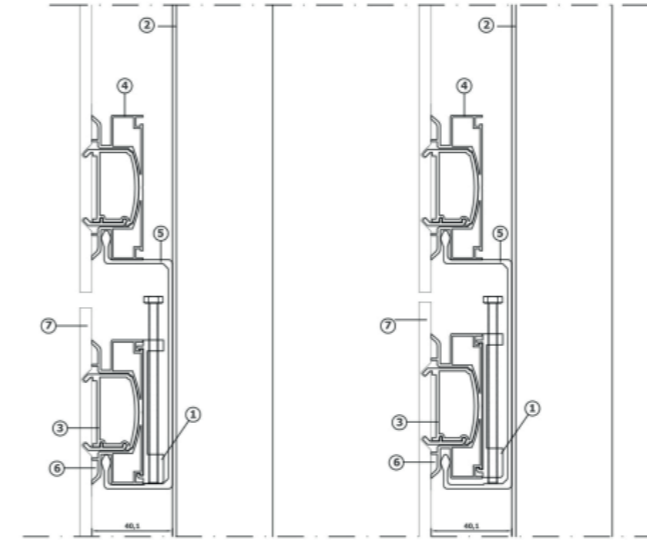

VERTICAL SECTION/ SECCIÓN VERTICAL

1. Arktech Full System regulator
2. Aluminum vertical profile T 110x50x2
3. Internal clamp Arktech Full System
4. External profile union Arktech Full System
5. Continuous profile double Arktech Full System
6. Space for the polyurethane adhesive (optional)
7. Exterior cladding

1. Regulador Arktech Full System
2. Perfil vertical aluminio T 110x50x2
3. Grapa interior Arktech Full System
4. Perfil exterior Arktech Full System
5. Perfil continuo doble Arktech Full System
6. Espacio previsto para alojar el pegamento de poliuretano (opcional)
7. Revestimiento exterior

MECHANIZED DETAILS/ DETALLES MECANIZADO

1. The distance that separates the groove will always be 36 mm on the inside of it, this can vary a few tenths depending on the type of mesh. The interior clamp must always be securely fastened.
2. The cutting depth shall be 4.5 mm perpendicular to the plate table ≥ 6 mm.
3. The cutting depth shall be 3.5 mm perpendicular to the plate table 5.6 mm.
4. Grooves are inclined 45°.
5. The distance of the machining from the edge of the plate determines the length of the joint.
6. The grooves will have a thickness of 3 mm always respecting the inside dimension of the machining.

1. La distancia que separa las ranuras siempre será de 36 mm en la parte interior de la misma, esto puede variar algunas décimas según el tipo de malla. La grapa interior siempre tiene que quedar bien sujeta.
2. La profundidad del corte siempre será de 4.5 mm perpendicular a la tabla en placas de ≥ 6 mm.
3. La profundidad del corte siempre será de 3.5 mm perpendicular a la tabla en placas de 5.6 mm.
4. Las ranuras están inclinadas a 45°.
5. La distancia del mecanizado respecto al borde de la placa determina la longitud de la huella.
6. Las ranuras tendrán un espesor de 3 mm siempre respetando la cota interior del mecanizado.

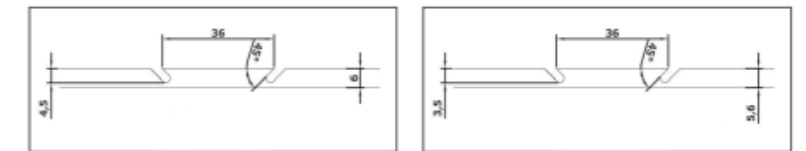

Detail with important system dimensions
Detalle con las cotas importantes del sistema

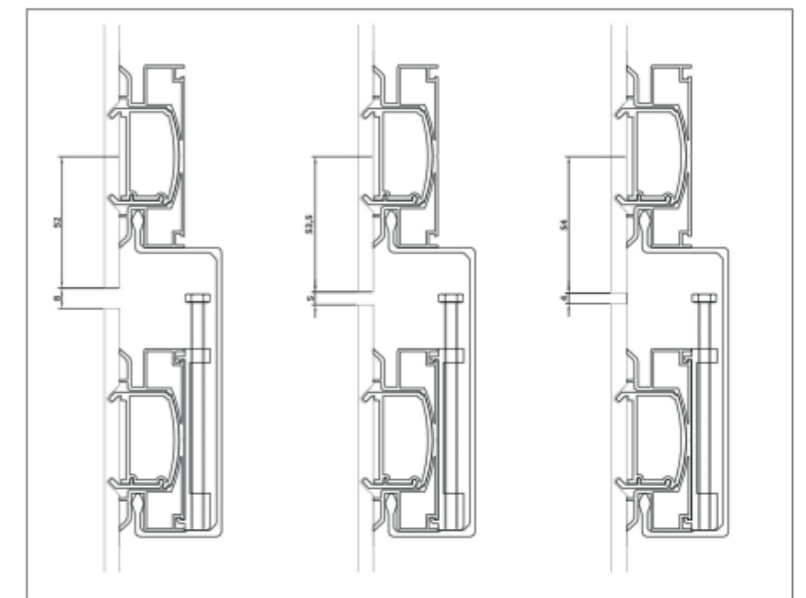

Most common joint length detail / Detalle de longitud de huella más comunes

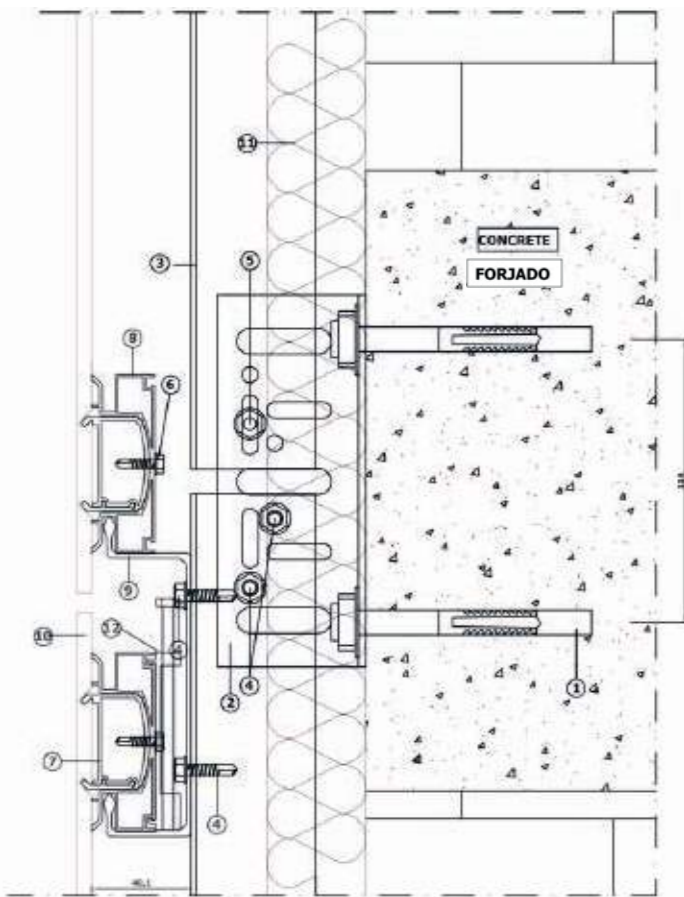

VERTICAL SECTION/ SECCIÓN VERTICAL

1. Anchorage MTA 8x90 stainless A2
2. Aluminum bracket 150x65x60x3
3. Aluminum vertical profile T 110x50x2
4. Screw DIN 7504-K 6.3x25 stainless steel A2
5. Screw DIN 7504-K 6.3x25 stainless steel A2 with washer EPDM
6. Screw DIN 7504-K 4.8x16 stainless steel A2
7. Internal clamp Arktech Full System
8. External profile union Arktech Full System
9. Continuous profile double Arktech Full System
10. Exterior cladding
11. Insulation
12. Arktech Full System regulator

1. Anclaje MTA 8x90 inox A2
2. Escuadra de aluminio 150x65x60x3
3. Perfil vertical aluminio T 110x50x2
4. Tornillo DIN 7504-K 6.3x25 inox A2
5. Tornillo DIN 7504-K 6.3x25 inox A2 con arandela EPDM
6. Tornillo DIN 7504-K 4.8x16 inox A2
7. Grapa interior Arktech Full System
8. Perfil exterior Arktech Full System
9. Perfil continuo doble Arktech Full System
10. Revestimiento exterior
11. Aislante
12. Regulador Arktech Full System



CE Marking declares conformity of our products with the technical and legal requirements for safety
 Marcado CE que declara la conformidad de todos nuestros productos con los requisitos legales y técnicos en materia de seguridad.



CCC Certificate that guarantees that our products meet the standard of radioactivity.
 Certificado CCC que avala que nuestros productos cumplen con el estándar de radioactividad.



Certificate of content in COVs which states that our products are exempt and belong to type A.
 Certificado del contenido en COVs que declara que nuestros productos están exentos y son de tipo A.



LEED certificate that guarantees compliance with a set of rules on the use of strategies aimed at sustainability in buildings.
 Certificado LEED que avala el cumplimiento de un conjunto de normas sobre la utilización de estrategias encaminadas a la sostenibilidad en edificios.



AENOR certification, for implementing and maintaining a Quality Management System for the following scope: design, development, manufacture and marketing ceramic tiles that meet fulfills the requirements of the following standard ISO 9001:2015 Registrer Number: ER-0498/2020.
 Certificación de AENOR, para la aplicación y mantenimiento de un Sistema de Gestión de Calidad para el siguiente ámbito: diseñar, desarrollar, fabricar y comercializar baldosas cerámicas que cumplan los requisitos de Norma ISO 9001:2015 Número de registro: ER-0498/2020.



In compliance with UNE normative documents created in the Technical Committees for Standardization of the Spanish Association for Standardization and Certification.
 En cumplimiento con los documentos normativos UNE creados en los Comités Técnicos de Normalización de la Asociación Española de Normalización y Certificación.



DAPcons certification, EPD ecolabeling programme for pioneering construction in Spain which follows European guidelines and is regulated by ISO 14025 and 15804 standards.
 Certificación DAPcons, programa de ecoetiquetado de EPD de la construcción pionero en España que sigue las directrices europeas y regulado por las normas ISO 14025 y 15804.



Technical Approval Document - DIT
 Documento de Idoneidad Técnica - DIT.



The AAI includes all environmental aspects, and other related aspects considered by the competent environmental authorities, in accordance with basic state and corresponding autonomous legislation.
 La AAI incluye todos los aspectos ambientales, y aquellos otros relacionados que consideren las autoridades ambientales competentes, de acuerdo con la legislación básica estatal y las correspondientes autonómicas.



The quality and impartiality of the certification process, and the level of its requirements form the basis of the technical added value of QB certification.
 La calidad e imparcialidad del proceso de certificación y el nivel de sus requisitos constituyen la base del valor añadido técnico de la certificación QB.



NSF certification assures suppliers, retailers, regulators and consumers that an independent organisation has reviewed the manufacturing process and determined that the product meets specific standards of safety, quality, sustainability or performance.
 La certificación de NSF asegura a los proveedores, minoristas, entes reguladores y consumidores que una organización independiente ha revisado el proceso de fabricación y ha determinado que el producto cumple con estándares específicos de seguridad, calidad, sostenibilidad o desempeño.



A permit, issued by SASO, to use the Quality Mark on products, which verifies that the facility has an effective management system that ensures production conformity with the General Technical Regulation, granting procedure and Saudi standard specification.
 Permiso, expedido por SASO, para utilizar la marca de calidad en los productos, que verifica que la instalación dispone de un sistema de gestión eficaz que garantiza la conformidad de la producción con el Reglamento Técnico General, el procedimiento de concesión y la especificación de la norma saudí.

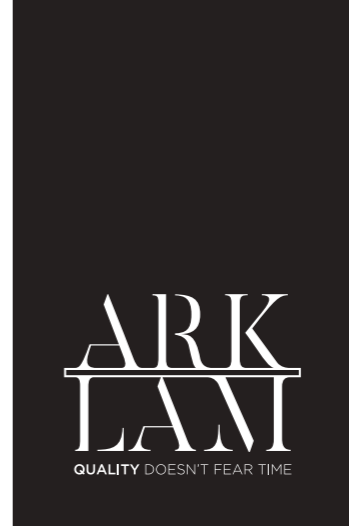

CERTIFICATIONS & AWARDS

CERTIFICADOS Y DISTINCIONES



PREMIO nan
 arquitectura y construcción
 AL MEJOR MATERIAL PARA PAVIMENTO Y REVESTIMIENTO
 2018



2018



Cámara Castellón
 PREMIO A LA EXPORTACIÓN PYME EXPORTADORA
 2017





Arklam reserves the right to make changes in this catalogue for the benefit of the product and the customer. All names, measures and benchmarks of the pieces are also available on the website, this avoiding typographical error that may have occurred at the time of printing this catalogue. Due to printing processes, the colors of the pieces represented, may have a slight variation from the original color.

In accordance with current legislation, the total or partial reproduction of this publication by any means or procedure, computer processing or any form of transfer of the same without prior written permission of the copyright holders are prohibited.

All images and content in this publication are the property of Saniceramic Group.

Saniceramic Group reserves all rights and, in particular, those of reproduction, distribution, public communication and transformation, even partial.

© 2023 Saniceramic Group. All rights reserved.

Arklam se reserva el derecho de introducir modificaciones en este catálogo en beneficio del producto y del cliente. Todos los nombres, medidas y referencias de las piezas se encuentran también disponibles en nuestra página web, evitando de este modo errores tipográficos que se hayan podido producir a la hora de imprimir este catálogo. Debido a los procesos de impresión, los colores de las piezas representadas, pueden sufrir una leve variación respecto al color original.

Quedan prohibidos, conforme a la legislación vigente, la reproducción total o parcial de esta publicación por cualquier medio o procedimiento, el tratamiento informático o cualquier forma de cesión de la misma sin autorización previa y por escrito de los titulares del copyright.

Todas las imágenes y el contenido de esta publicación son propiedad de Saniceramic Group.

Saniceramic Group se reserva todos los derechos y, en particular, los de reproducción, distribución, comunicación pública y transformación, incluso parcial.

© 2023 Saniceramic Group. Todos los derechos reservados.

www.arklam.com | arklam@arklam.es
Tel.: 0034 964 913 171 | Fax.: 0034 964 657 426
Ctra. de Alcora, Km. 7,5 | 12130 Sant Joan de Moró
Castellón (Spain)

Together on social networks
Juntos en redes sociales

